

## SLITE



ULTIMATE SLIDING CONCEPT  
WITH MINIMALIST  
EXCELLENT LOOK

  
**PROVEX**  
comfort in the bathroom

INDICE S-LITE  
 INHALT S-LITE  
 INDEX S-LITE  
 INDICE S-LITE

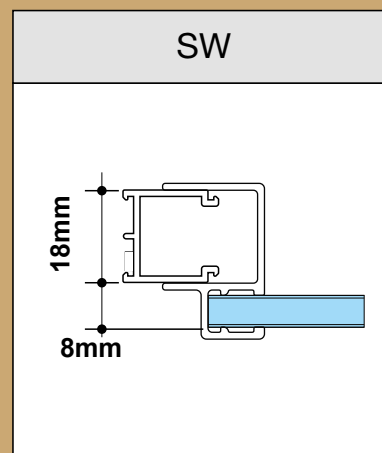
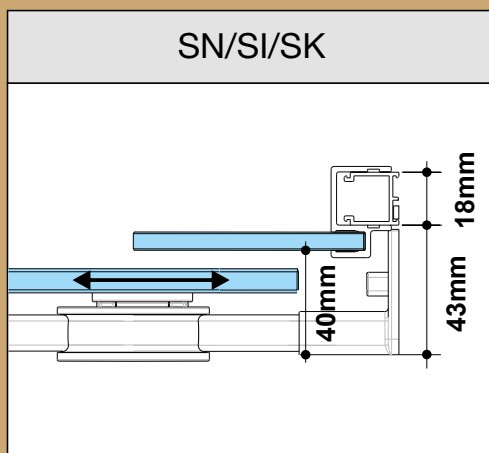
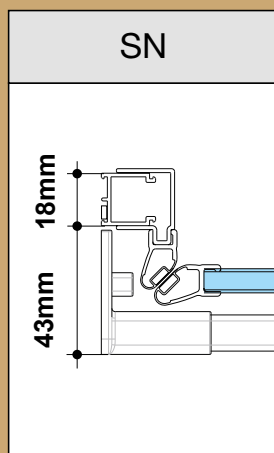
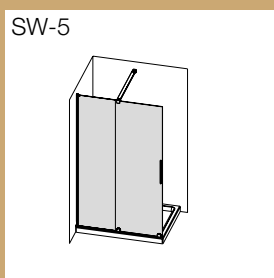
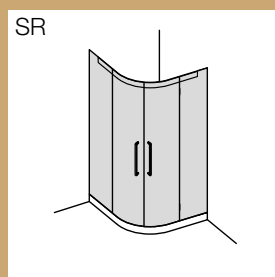
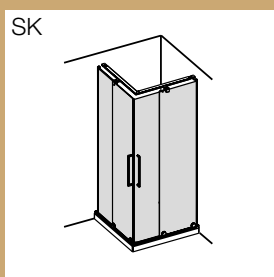
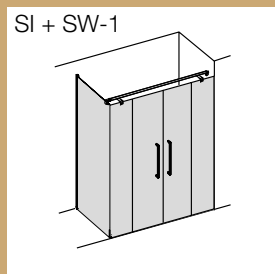
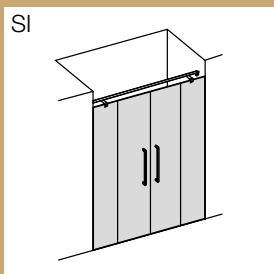
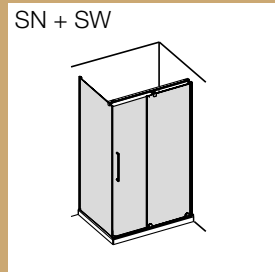
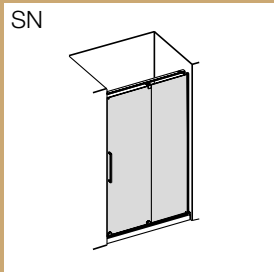



## BOX DOCCIA SENZA TELAIO

- Design Studio Talocci
- Altezza 1950 mm ed estensibilità da 25 a 50 mm
- Spessore vetro 8 mm per le porte scorrevoli
- Tenuta stagna testata a 11 litro/minuto
- Posizione delle ruote in basso garantisce un ideale scorrimento
- Ruote a cuscinetto regolabili in altezza
- Massima stabilità grazie al sostegno continuo e montaggio semplice con dima
- Viti planari all'interno del box facilitano la pulizia
- Profilo a parete senza bisogno di silicone e a scomparsa



## RAHMENLOSE KABINEN

- Design Studio Talocci
- Höhe 1950 mm und Verstellbereich von 25 - 50 mm
- Glasstärke 8 mm für die Schiebetüren
- Getestete Wasserdichtheit von 11 Liter/Minute
- Positionierung der Räder unten garantiert ideale Gleiteigenschaft
- Kugelgelagerte Räder mit Höhenverstellung
- Höchste Stabilität durch durchgehende Stütze und einfachste Montage mit Schablone
- Ideale Reinigung durch versenkte Schrauben im Glas
- Silikonfreier Wandanschluss und Schattenprofil

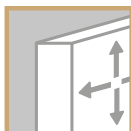

## FRAMELESS SHOWER ENCLOSURE

- Design Studio Talocci
- Height 1950 mm and adjustment from 25 - 50 mm
- 8 mm glass sliding door
- Tested to be watertight 11 litres per minute
- Bottom wheels ensure smooth silent door motion
- Ball bearing wheels adjustable in height
- High stability through continuous support and easy assembly
- Screws are sunk into the glass and facilitate the cleaning
- Silicone-free wall junction and shadow profile



## CABINA DE DUCHA SIN PERFIL

- Design Studio Talocci
- Altura 1950 mm y extensibilidad de 25 - 50 mm
- Vidrio de 8 mm de espesor para puertas corredizas
- No sale el agua al exterior de 11 litros/minutos
- La posición de las ruedas por debajo, garantiza un deslizamiento ideal
- Ruedas con cojinetes regulables en altura
- Máxima estabilidad gracias al apoyo continuo y montaje simple
- Tornillos planos en el interior de la cabina facilitando la limpieza
- Fijación a pared sin necesidad de silicona y perfil mural oculto

# S-LITE SN

PORTA SCORREVOLE  
SCHIEBETÜR  
SLIDING DOOR  
PUERTA CORREDERA





High  
GLASS



SN  
1950



GH  
High  
Glass

GL

8/6 mm



05



Descrizione Articolo Artikelbezeichnung Model description Descripción artículo	Articolo Artikel Model Código	Misura piatto doccia Tassenmaß Tray size Medidas del plato mm	Estensibilità Verstellbarkeit Adjustability Extensibilidad mm	Misura Maß Size Medidas mm	
				A**	B
 <p><b>Porta scorrevole*</b> Schiebetür* Sliding door* Puerta corredera*</p>	0005 SN - L/R	1000	950 - 1000	380	485
	0007 SN - L/R	1200	1150 - 1200	480	585
	0009 SN - L/R	1400	1350 - 1400	580	685
	0057 SN - L/R	SPECIAL	950 - 1209		
	0079 SN - L/R	SPECIAL	1210 - 1410		

\*Lato fisso della porta da definire nell'ordine (sinistra L - destra R) / Montageseite des fixen Elements bei Bestellung definieren (links L - rechts R)  
Define the fix side when ordering (left L - right R) / Lado fijo se indican en el pedido (izquierda L - derecha R)

\*\*Attenzione alla misura A (entrata) / Achtung auf das Maß A (Einstieg) / Attention to the size A (entrance) / Atención en la medida A (entrada)

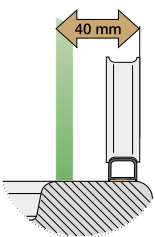

SN - L



SN - R



SN - L

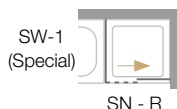

SN - R

SW-1  
(Special)

# S-LITE SN + SW

PORTA SCORREVOLE CON LATERALE

SCHIEBETÜR MIT SEITENTEIL

SLIDING DOOR WITH SIDE PANEL

PUERTA CORREDERA CON PARED LATERAL





High  
GLASS



SW  
1950

SN  
1950



GH  
High  
Glass

GL



05



Descrizione Articolo Artikelbezeichnung Model description Descripción artículo	Articolo Artikel Model Código	Misura piatto doccia Tassenmaß Tray size Medidas del plato mm	Estensibilità Verstellbarkeit Adjustability Extensibilidad mm	Misura Maß Size Medidas mm	
				A**	B
 <b>Porta scorrevole*</b> Schiebetür* Sliding door* Puerta corredera*	0015 SN - L/R	1000	975 - 1000	390	485
	0017 SN - L/R	1200	1175 - 1200	490	585
	0019 SN - L/R	1400	1375 - 1400	590	685
	1057 SN - L/R	SPECIAL	950 - 1209		
	1079 SN - L/R	SPECIAL	1210 - 1410		

\*Lato fisso della porta da definire nell'ordine (sinistra L - destra R) / Montageseite des fixen Elements bei Bestellung definieren (links L - rechts R)  
 Define the fix side when ordering (left L - right R) / Lado fijo se indican en el pedido (izquierda L - derecha R)

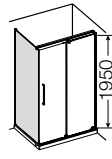
 <b>Laterale per porta scorrevole</b> Seitenteil für Schiebetür Side panel for sliding door Pared lateral para puerta corredera	0001 SW	700	675 - 700	8 mm			
	0002 SW	750	725 - 750				
	0003 SW	800	775 - 800				
	0004 SW	900	875 - 900				
	0005 SW	1000	975 - 1000				
	0014 SW	SPECIAL	600 - 909				
	0047 SW	SPECIAL	910 - 1210				

\*\*Attenzione alla misura A (entrata) / Achtung auf das Maß A (Einstieg) / Attention to the size A (entrance) / Atención en la medida A (entrada)

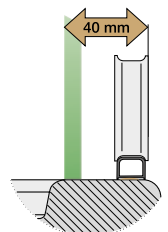

SN - L

SW



SN - R

SW-1



SN - L

SW



SN - R

SW-1

# S-LITE SI + SW-1

PORTE SCORREVOLI IN LINEA

SCHIEBETÜREN IN LINIE

SLIDING DOORS IN LINE

PUERTAS CORREDERAS IN LINEA







High  
GLASS



SI 1950	SW-1 1950	
------------	--------------	--

GH High Glass	GL	8/6 mm
------------------	----	--------

05	
----	--

Descrizione Articolo Artikelbezeichnung Model description Descripción artículo	Articolo Artikel Model Código	Misura piatto doccia Tassenmaß Tray size Medidas del plato mm	Estensibilità Verstellbarkeit Adjustability Extensibilidad mm	Misura Maß Size Medidas mm		
				A	B	
<p><b>Porte scorrevoli in linea - porte</b> Schiebetüren in Linie - Türen Sliding doors in line - doors Puertas correderas in linea - puertas</p>	0009 SI-T	1400	1350 - 1400	8 mm	515	
	0011 SI-T	1600	1550 - 1600		565	
	0012 SI-T	1700	1650 - 1700		565	
	0013 SI-T	1800	1750 - 1800		665	
<p><b>Porte in linea con sostegno - laterali</b> Schiebetüren mit Stütze - Seitenteile Sliding doors with support - side panels Puertas correderas con apoyo - laterales</p>	0009 SI-S	1400	1350 - 1400	6 mm	432	
	0011 SI-S	1600	1550 - 1600		507	
	0012 SI-S	1700	1650 - 1700		557	
	0013 SI-S	1800	1750 - 1800		557	
<p><b>Laterale per porta scorrevole in linea</b> Seitenteil für Schiebetür in Linie Side panel for sliding door in line Pared lateral para puerta in linea</p>	1001 SW	700	680 - 705	6 mm		
	1002 SW	750	730 - 755			
	1003 SW	800	780 - 805			
	1004 SW	900	880 - 905			
	1005 SW	1000	980 - 1005			

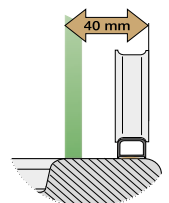
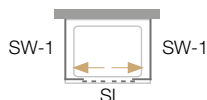

# S-LITE SK

BOX AD ANGOLO SCORREVOLE

ECKKABINE MIT SCHIEBETÜREN

CORNER ENTRY WITH SLIDING DOORS

CABINA ANGULAR CON PUERTAS CORREDERAS





Descrizione Articolo Artikelbezeichnung Model description Descripción artículo	Articolo Artikel Model Código	Misura piatto doccia Tassenmaß Tray size Medidas del plato mm	Estensibilità Verstellbarkeit Adjustability Extensibilidad mm	Misura Maß Size Medidas mm	
				A**	B
 <p><b>Box ad angolo scorrevole*</b> Eckkabine mit Schiebetüren* Corner entry with sliding doors* Cabina angular con puertas correderas*</p>	0001 SK - L/R	700	665 - 690	335	335
	0002 SK - L/R	750	715 - 740	370	360
	0003 SK - L/R	800	765 - 790	405	385
	0004 SK - L/R	900	865 - 890	475	435
	0005 SK - L/R	1000	965 - 990	545	485
	0014 SK - L/R	SPECIAL	650 - 909		
	0047 SK - L/R	SPECIAL	910 - 1210		

\*Usate 1 articolo cad. di SK-L e SK-R / Verwenden Sie je 1 x Artikel SK-L und SK-R / Use 1 article each SK-L and SK-R / Le rogamos de usar 1 cad. SK-L y SK-R

\*\*Attenzione alla misura A (entrata) / Achtung auf das Maß A (Einstieg) / Attention to the size A (entrance) / Atención en la medida A (entrada)

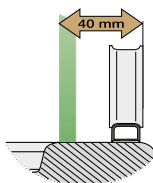
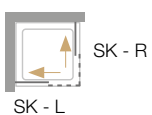
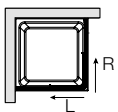

# S-LITE SR

BOX ROTONDO SCORREVOLE

RUNDKABINE MIT SCHIEBETÜREN

SHOWER CUBICLE WITH SLIDING DOORS

CABINA SEMICIRCULAR CON PUERTAS CORREDERAS



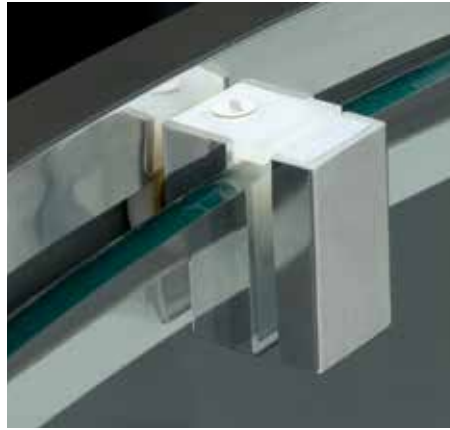

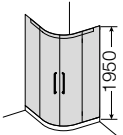
Descrizione Articolo Artikelbezeichnung Model description Descripción artículo	Articolo Artikel Model Código	Misura piatto doccia Tassenmaß Tray size Medidas del plato mm		Estensibilità Verstellbarkeit Adjustability Extensibilidad mm		Misura piatto installato Tasseneinbaumaß Tray installation measure Medidas del plato instalado mm		Misura Maß Size Medidas mm	
		L	R	L	R	L	R	A	
			<b>Box rotondo scorrevole</b> Rundkabine mit Schiebetüren Shower cubicle with sliding doors Cabina semicircular con puertas correderas	6003 SR	800 x 800 <b>R 550</b>	770 - 795	780 - 805	440	
	6004 SR	900 x 900 <b>R 550</b>	870 - 895	880 - 905	460				
	6005 SR	1000 x 1000 <b>R 550</b>	970 - 995	980 - 1005	460				
	6304 SR	800 x 900 <b>R 550</b>	770 - 795 / 870 - 895	780 - 805 / 880 - 905	440				
	6403 SR	900 x 800 <b>R 550</b>	870 - 895 / 770 - 795	880 - 905 / 780 - 805	440				
	6405 SR	900 x 1000 <b>R 550</b>	870 - 895 / 970 - 995	880 - 905 / 980 - 1005	460				
	6504 SR	1000 x 900 <b>R 550</b>	970 - 995 / 870 - 895	980 - 1005 / 880 - 905	460				
	4003 SR	800 x 800 <b>R 500</b>	770 - 795	780 - 805	440				
	4004 SR	900 x 900 <b>R 500</b>	870 - 895	880 - 905	460				
	4005 SR	1000 x 1000 <b>R 500</b>	970 - 995	980 - 1005	460				
	4304 SR	800 x 900 <b>R 500</b>	770 - 795 / 870 - 895	780 - 805 / 880 - 905	440				
	4403 SR	900 x 800 <b>R 500</b>	870 - 895 / 770 - 795	880 - 905 / 780 - 805	440				
	4305 SR	800 x 1000 <b>R 500</b>	770 - 795 / 970 - 995	780 - 805 / 980 - 1005	440				
	4503 SR	1000 x 800 <b>R 500</b>	970 - 995 / 770 - 795	980 - 1005 / 780 - 805	440				
	2104 SR	700 x 900 <b>R 380</b>	670 - 695 / 870 - 895	680 - 705 / 880 - 905	380				
	2401 SR	900 x 700 <b>R 380</b>	870 - 895 / 670 - 695	880 - 905 / 680 - 705	380				
	2305 SR	800 x 1000 <b>R 380</b>	770 - 795 / 970 - 995	780 - 805 / 980 - 1005	380				
	2503 SR	1000 x 800 <b>R 380</b>	970 - 995 / 770 - 795	980 - 1005 / 780 - 805	380				

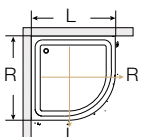

# S-LITE SW-5

ANTA SCORREVOLE CON FISSO

2-TEILIGE SCHIEBETÜR MIT FESTFELD

DOUBLE SLIDING DOOR WITH FIX PANEL

PUERTA CORREDERA CON FIJO



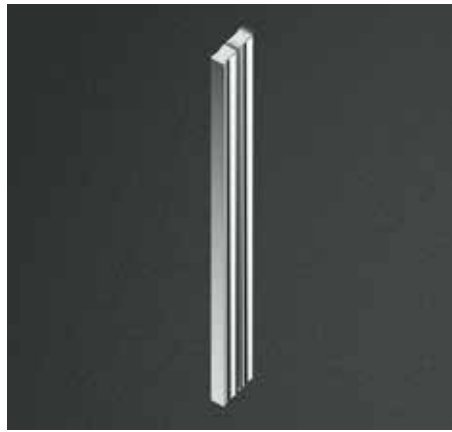

High  
GLASS



SW-5  
1950



GH  
High  
Glass

GL

8/6 mm

05

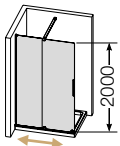

Descrizione Articolo Artikelbezeichnung Model description Descripción artículo	Articolo Artikel Model Código	Estensibilità Verstellbarkeit Adjustability Extensibilidad mm	Misura Maß Size Medidas mm		
			A	B	C
 <p><b>Anta scorrevole con fisso</b> 2-teilige Schiebetür mit Festfeld Double sliding door with fix panel Puerta correderas con fijo</p>	5100 SW - L/R*	985 - 1010	500 - 1240	555	475
	5120 SW - L/R*	1185 - 1210	500 - 1240	655	575
	5140 SW - L/R*	1385 - 1410	500 - 1240	755	675
	5037 SW - L/R*	800 - 1209	500 - 1240		
	5079 SW - L/R*	1210 - 1410	500 - 1240		

\*Lato fisso della porta da definire nell'ordine (sinistra L - destra R) / Montageseite des fixen Elements bei Bestellung definieren (links L - rechts R)  
Define the fix side when ordering (left L - right R) / Lado fijo se indican en el pedido (izquierda L - derecha R)

