

KOMBI/KOMBI FREE



THE PERFECT COMBINATION
IN TECHNICALLY ADVANCED AND
AESTHETICALLY PLEASING SOLUTIONS

PROVEX
comfort in the bathroom

INDICE KOMBI/KOMBI FREE
 INHALT KOMBI/KOMBI FREE
 INDEX KOMBI/KOMBI FREE
 INDICE KOMBI/KOMBI FREE

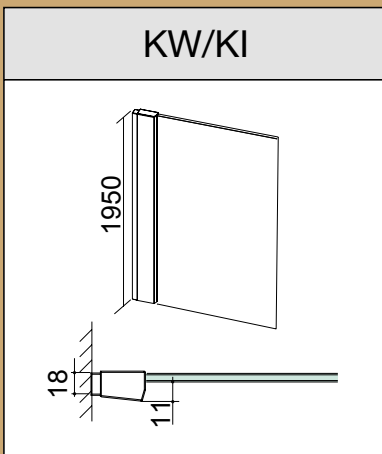
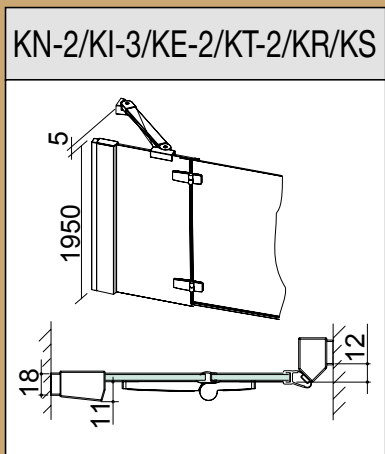
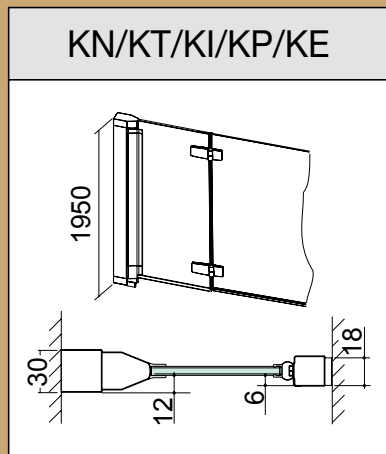
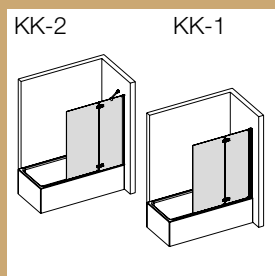
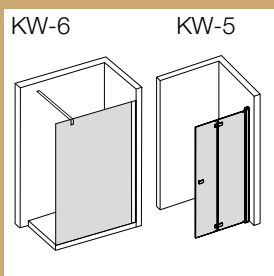
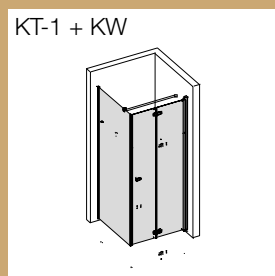
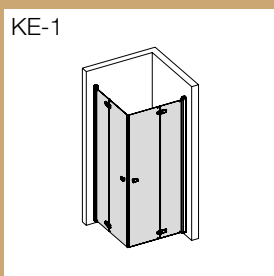
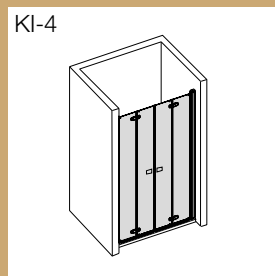
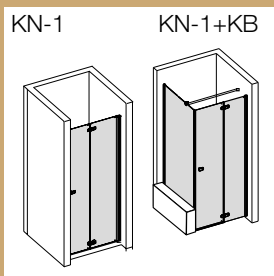
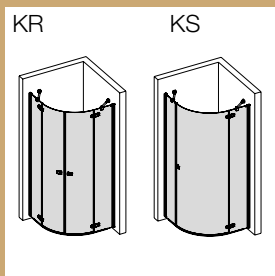
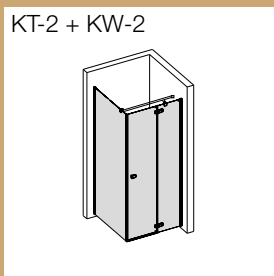
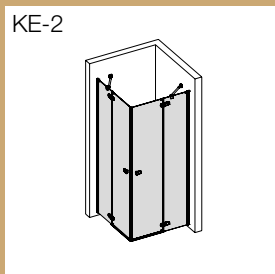
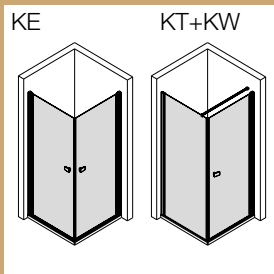
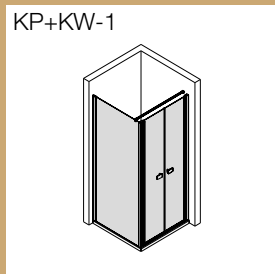
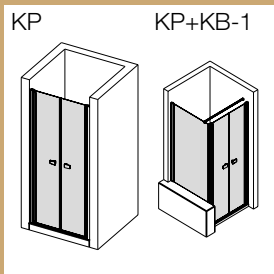
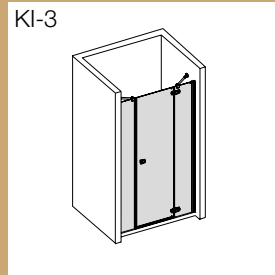
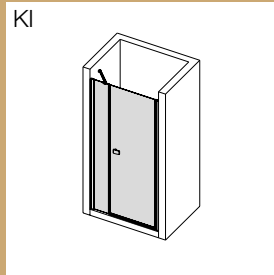
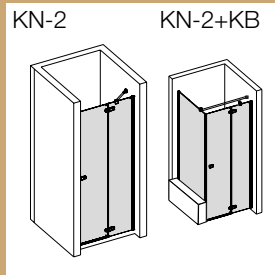
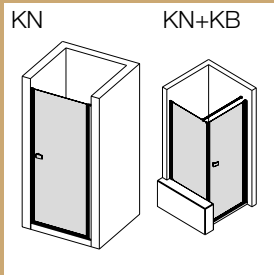



BOX DOCCIA CON TECNICA A CERNIERA

- Design Studio Provex
- Massima trasparenza con il sistema a cerniera
- Viti sono planari all'interno del box per una pulizia semplice e profonda
- Altezza 1950 mm e un'estensibilità da 25 – 50 mm
- Tenuta stagna testata a 11 litri/minuto
- Profilo a parete senza bisogno di silicone
- Porte con meccanismo di sollevamento/abbassamento



DUSCHKABINEN MIT SCHARNIERTECHNIK

- Design Studio Provex
- Maximale Transparenz durch die Scharniertechnik
- Scharnierschrauben sind im Glas für eine einfache Reinigung versenkt
- Kabinenhöhe 1950 mm und einen Verstellbereich von 25 – 50 mm
- Getestete Wasserdichtheit von 11 Liter/Minute
- Silikonfreier Wandanschluss und teilweise reversibel
- Türelemente mit Hebe- Senkmechanismus

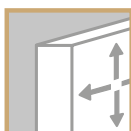

SHOWER ENCLOSURE WITH HINGE TECHNOLOGY

- Design Studio Provex
- Maximum transparency through hinge technology
- Hinge screws are sunken into the glass to simplify the cleaning
- Enclosures height of 1950 mm and adjustability from 25 - 50 mm
- Tested to be watertight 11 litres per minute
- Silicone free wall junction
- Door elements with up and down lifting mechanism



MAMPARAS DE DUCHA CON TECNOLOGÍA DE BISAGRA

- Design Studio Provex
- Máxima transparencia con el sistema de bisagra
- Tornillos planos en el interior de la cabina para facilitar la limpieza
- Altura 1950 mm y una extensibilidad de 25 – 50 mm
- No sale el agua al exterior de 11 litros/minutos
- Fijación a pared sin necesidad de silicona
- Puertas con mecanismo de levantamiento/descenso

KOMBI KN + KB

PORTA BASCULANTE SINGOLA + LATERALE PER VASCA
PENDELTÜR 1-TEILIG + SEITENTEIL FÜR BADEWANNE
PIVOT DOOR SINGLE + SIDE PANEL FOR BATHTUB
PUERTA BASCULANTE + LATERAL PARA BAÑERA

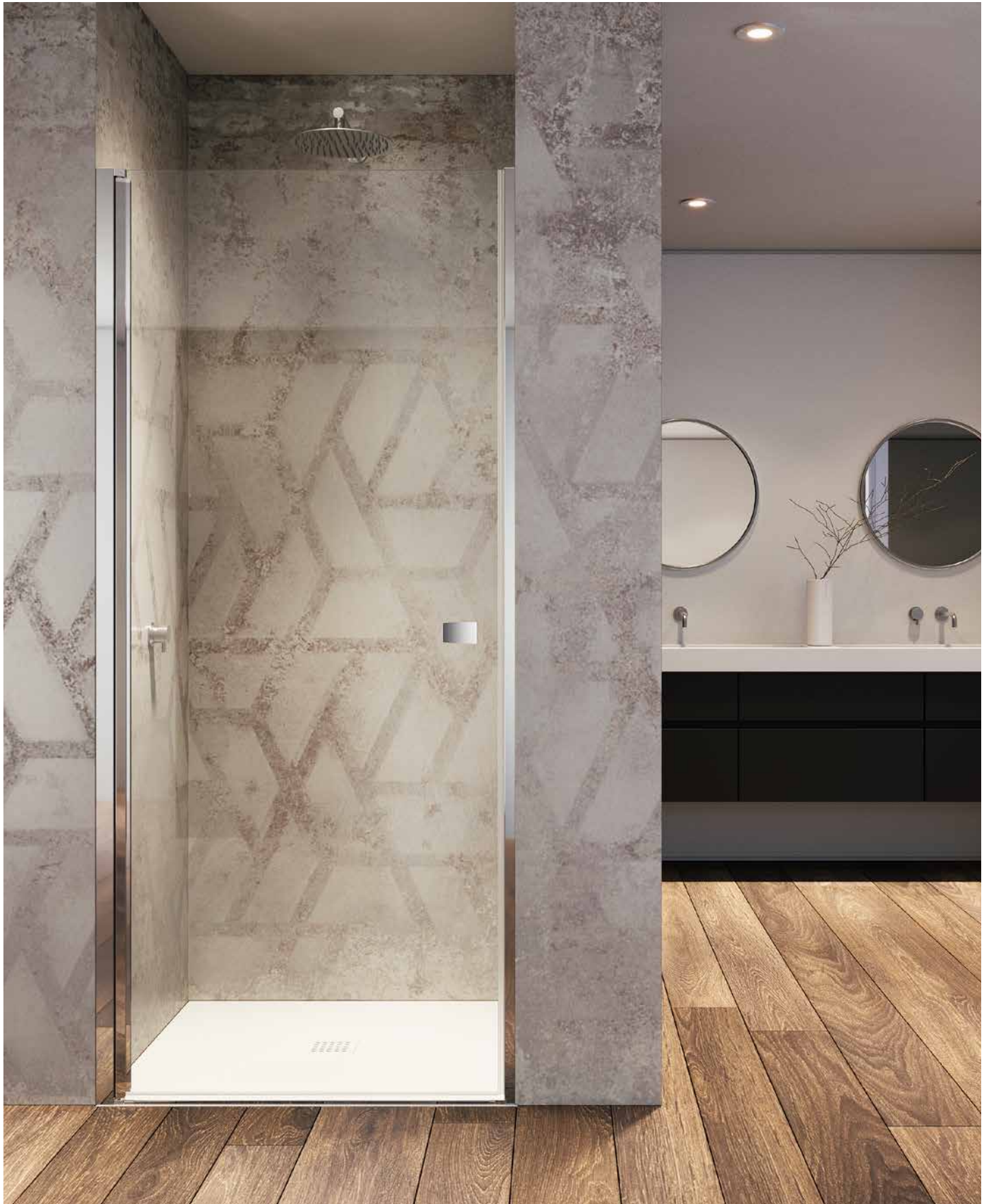



Descrizione Articolo Artikelbezeichnung Model description Descripción artículo	Articolo Artikel Model Código	Misura piatto doccia Tassenmaß Tray size Medidas del plato mm	Estensibilità Verstellbarkeit Adjustability Extensibilidad mm	Misura Maß Size Medidas mm		
				A	B	
Porta basculante singola Pendeltür 1-teilig Pivot door single Puerta basculante	0070 KN	700	670 - 705	592	590	
	0075 KN	750	720 - 755	642	690	
	0080 KN	800	770 - 805	692	690	
	0090 KN	900	870 - 905	792	790	
	0100 KN	1000	970 - 1005	892	890	
Laterale per vasca Seitenteil für Badewanne Side panel for bathtub Pared lateral para bañera	0015 KB*	700 - 1000	25			

* Articolo é sempre un fuori misura / Artikel ist immer Sondermaß / article is always special measure / artículo es siempre medida especial

Indicare sempre bordo piatto fino bordo vasca/muretto
 Oberkante Duschtasse bis Badewanne/Mauer immer angeben
 Indicate always shower tray to bathtub panel/wall
 Indique siempre borde superior plato de ducha y bañera/muro

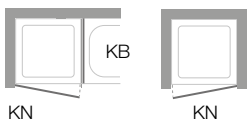

KOMBI KN-2 + KB

PORTA CON FISSO + LATERALE PER VASCA

TÜR MIT FESTFELD + SEITENTEIL FÜR BADEWANNE

DOOR WITH FIX PANEL + SIDE PANEL FOR BATHTUB

PUERTA CON FIJO + LATERAL PARA BAÑERA

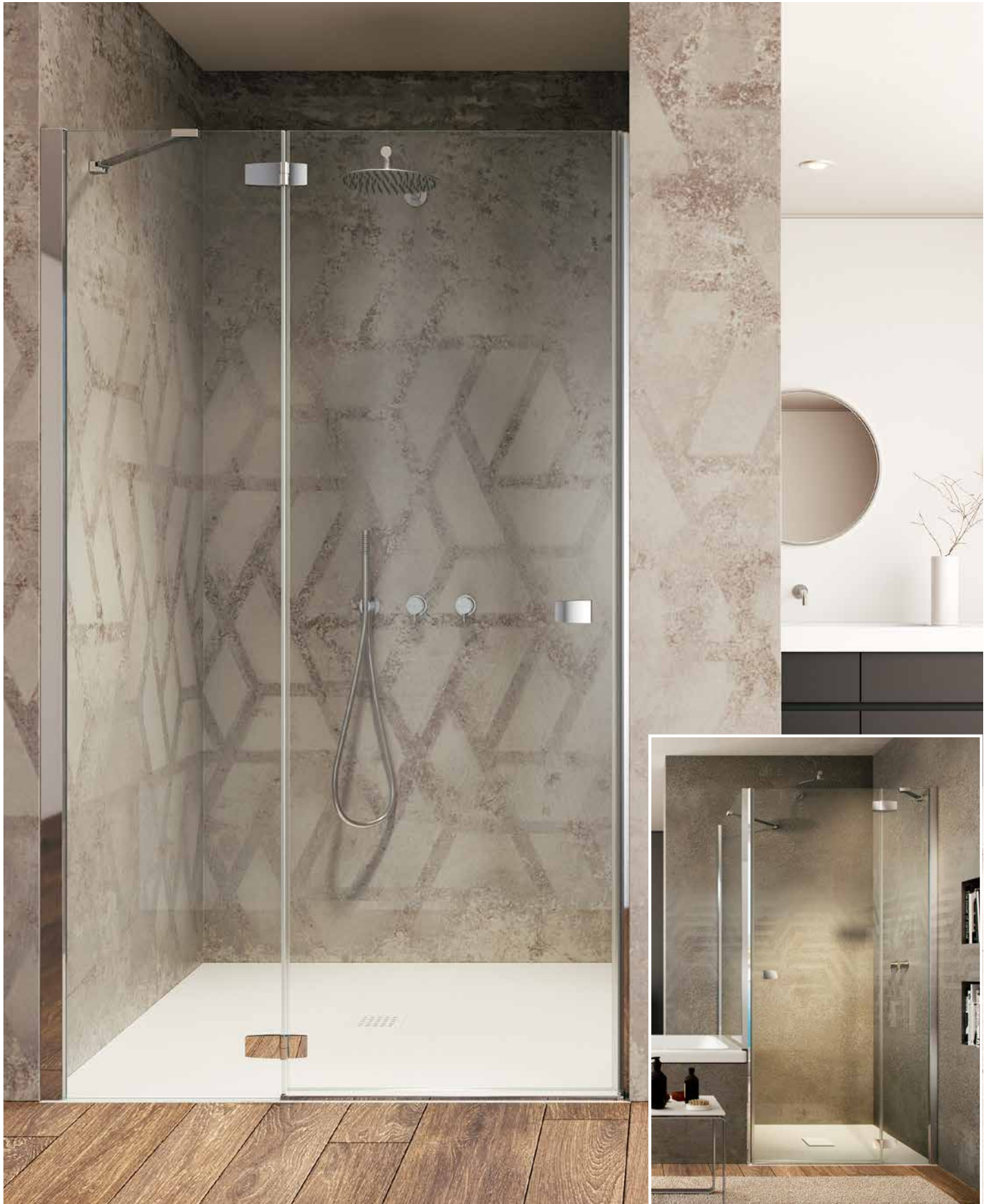



High
GLASS



KN-2 **KB**
1950 max 1800



GH **GL** **6 mm**
High Glass

05 **28**

Descrizione Articolo Artikelbezeichnung Model description Descripción artículo	Articolo Artikel Model Código	Misura piatto doccia Tassenmaß Tray size Medidas del plato mm	Estensibilità porta Verstellbarkeit Tür Adjustability door Extensibilidad puerta mm	Estensibilità laterale Verstellbarkeit Seitenteil Adjustability side panel Extensibilidad lateral mm	Misura Maß Size Medidas mm		
					A	B	C
 <p>Porta con fisso* Tür mit Festfeld* Door with fix panel* Puerta con fijo*</p>	2070 KN - L/R	700	670 - 705		410	250	440
	2075 KN - L/R	750	720 - 755		460	250	490
	2080 KN - L/R	800	770 - 805		510	250	540
	2090 KN - L/R	900	870 - 905		610	250	640
	2100 KN - L/R	1000	970 - 1005		660	300	690
	2120 KN - L/R	1200	1170 - 1205		660	500	690
	2140 KN - L/R	1400	1370 - 1405		740	620	770

*Il lato di montaggio della cerniera da definire nell'ordine (sinistra L - destra R) / Montageseite des Scharniers bei Bestellung definieren (links L - rechts R)
Define the hinge assembly side when ordering (left L - right R) / Lado bisagra de la asamblea se indican en el pedido (izquierda L - derecha R)

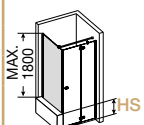
 <p>Laterale per vasca Seitenteil für Badewanne Side panel for bathtub Pared lateral para bañera</p>	0015 KB**	700 - 1000		25					

** Articolo é sempre un fuori misura / Artikel ist immer Sondermaß / article is always special measure / artículo es siempre medida especial

 **Indicare sempre bordo piatto fino bordo vasca/muretto**
Oberkante Duschtasse bis Badewanne/Mauer immer angeben
Indicate always shower tray to bathtub panel/wall
Indique siempre borde superior plato de ducha y bañera/muro

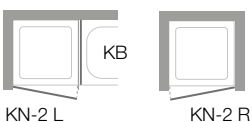

KN-2 L

KN-2 R

KOMBI KI

PORTA BASCULANTE IN LINEA
PENDELTÜR IN LINIE
PIVOT DOOR IN-LINE
PUERTA BASCULANTE EN LINEA





Descrizione Articolo Artikelbezeichnung Model description Descripción artículo	Articolo Artikel Model Código	Misura piatto doccia Tassenmaß Tray size Medidas del plato mm	Estensibilità Verstellbarkeit Adjustability Extensibilidad mm	Misura Maß Size Medidas mm		
				A	B	C
 <p>Porta basculante in linea Pendeltür in Linie Pivot door in-line Puerta basculante en línea</p> 	0100 KI	1000	950 - 1000	330	592	590
	0110 KI	1100	1050 - 1100	330	692	690
	0120 KI	1200	1150 - 1200	330	792	790
	0140 KI	1400	1350 - 1400	530	792	790



KOMBI KI-3

PORTA CON FISSI IN LINEA

TÜR MIT FESTFELDERN IN LINIE

DOOR WITH IN-LINE FIX PANELS

PUERTA CON FIJOS





High
GLASS



KI-3
1950



GH
High
Glass

GL

6 mm

05

28



Descrizione Articolo Artikelbezeichnung Model description Descripción artículo	Articolo Artikel Model Código	Misura piatto doccia Tassenmaß Tray size Medidas del plato mm	Estensibilità Verstellbarkeit Adjustability Extensibilidad mm	Misura Maß Size Medidas mm			
				A	B	C	D
 <p>Porta con fissi in linea* Tür mit Festfeldern in Linie* Door with in-line fix panels* Puerta con fijos*</p>	3120 KI - L/R	1200	1160 - 1210	325	590	560	310
	3140 KI - L/R	1400	1360 - 1410	325	690	660	410
	3160 KI - L/R	1600	1560 - 1610	425	690	660	510

*Il lato di montaggio della cerniera da definire nell'ordine (sinistra L - destra R) / Montageseite des Scharniers bei Bestellung definieren (links L - rechts R)
Define the hinge assembly side when ordering (left L - right R) / Lado bisagra de la asamblea se indican en el pedido (izquierda L - derecha R)



KI-3 L



KI-3 R Special

KW-3

KOMBI KP + KB-1

PORTA SALOON + LATERALE PER VASCA

PENDELTÜR 2-TEILIG + SEITENTEIL FÜR BADEWANNE

SALOON DOOR DOUBLE + SIDE PANEL FOR BATHTUB

PUERTA BASCULANTE DOBLE + LATERAL PARA BAÑERA





KP 1950	KB-1 max 1800	
-------------------	-------------------------	--

GH High Glass	GL	6 mm
-------------------------	-----------	-----------------

05	28	
-----------	-----------	--

Descrizione Articolo Artikelbezeichnung Model description Descripción artículo	Articolo Artikel Model Código	Misura piatto doccia Tassenmaß Tray size Medidas del plato mm	Estensibilità Verstellbarkeit Adjustability Extensibilidad mm	Misura Maß Size Medidas mm		
				A	B	
Porta saloon Pendeltür 2-teilig Saloon door double Puerta basculante doble	0070 KP	700	657 - 707	545	270	
	0075 KP	750	707 - 757	595	295	
	0080 KP	800	757 - 807	645	320	
	0090 KP	900	857 - 907	745	370	
	0100 KP	1000	957 - 1007	845	420	
	0120 KP	1200	1157 - 1207	1045	520	
Laterale per vasca Seitenteil für Badewanne Side panel for bathtub Pared lateral para bañera	1015 KB*	700 - 1000	25			

* Articolo é sempre un fuori misura / Artikel ist immer Sondermaß / article is always special measure / artículo es siempre medida especial

	Bordo piatto fino bordo vasca/muretto Oberkante Duschtasse bis Badewanne/Mauer Shower tray to bathtub panel/wall Borde superior plato de ducha y bañera/muro
--	--



KOMBI KP + KW-1

PORTA SALOON + LATERALE

PENDELTÜR 2-TEILIG + SEITENTEIL

SALOON DOOR DOUBLE + SIDE PANEL

PUERTA BASCULANTE DOBLE + LATERAL



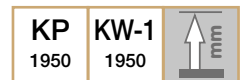

Descrizione Articolo Artikelbezeichnung Model description Descripción artículo	Articolo Artikel Model Código	Misura piatto doccia Tassenmaß Tray size Medidas del plato mm	Estensibilità Verstellbarkeit Adjustability Extensibilidad mm	Misura centro vetro Mitte Glasmaß Glass size middle Medida vidrio centro mm	Misura Maß Size Medidas mm		
					A	B	
<p>Porta saloon Pendeltür 2-teilig Saloon door double Puerta basculante doble</p> <p>IN OUT</p>	0070 KP	700	675 - 725	660 - 710	545	270	
	0075 KP	750	725 - 775	710 - 760	595	295	
	0080 KP	800	775 - 825	760 - 810	645	320	
	0090 KP	900	875 - 925	860 - 910	745	370	
	0100 KP	1000	975 - 1025	960 - 1010	845	420	
	0120 KP	1200	1175 - 1225	1160 - 1210	1045	520	
<p>Laterale per porta basculante Seitenteil für Pendeltür Side panel for saloon door Lateral para puerta basculante</p>	1070 KW	700	665 - 690	650 - 675			
	1075 KW	750	715 - 740	700 - 725			
	1080 KW	800	765 - 790	750 - 775			
	1082 KW		798 - 823	783 - 808			
	1090 KW	900	865 - 890	850 - 875			
	1092 KW		898 - 923	883 - 908			
	1100 KW	1000	965 - 990	950 - 975			
1102 KW		998 - 1023	983 - 1008				

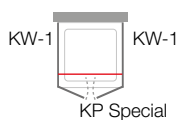

KOMBI KE

BOX AD ANGOLO PORTA BASCULANTE
ECKEINSTIEG PENDELTÜR
CORNER ENTRY PIVOT DOOR
CABINA ANGULAR PUERTA BASCULANTE





Descrizione Articolo Artikelbezeichnung Model description Descripción artículo	Articolo Artikel Model Código	Misura piatto doccia Tassenmaß Tray size Medidas del plato mm	Estensibilità Verstellbarkeit Adjustability Extensibilidad mm	Misura centro vetro Mitte Glasmaß Glass size middle Medida vidrio centro mm	Misura Maß Size Medidas mm A
<p>Box ad angolo porta basculante* EckEinstieg Pendeltür* Corner entry pivot door* Cabina angular puerta basculante*</p>	0070 KE	700	667 - 692	652 - 677	835
	0075 KE	750	717 - 742	702 - 727	905
	0080 KE	800	767 - 792	752 - 777	975
	0082 KE		802 - 827	787 - 812	1025
	0090 KE	900	867 - 892	852 - 877	1115
	0092 KE		902 - 927	887 - 912	1165
	0100 KE	1000	967 - 992	952 - 977	1260
	0102 KE		1002 - 1027	987 - 1012	1305

*Usate 2 articoli KE per il box completo / Verwenden Sie 2 x Artikel KE für die komplette Kabine / Use 2 article KE for the complete box / Le rogamos de usar 2 x KE per para la cabina completa

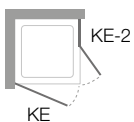

KOMBI KT + KW

PORTA BASCULANTE CON SOSTEGNO + LATERALE

PENDELTÜR MIT STÜTZE + SEITENTEIL

PIVOT DOOR WITH SUPPORT + SIDE PANEL

PUERTA BASCULANTE CON SOPORTE + LATERAL



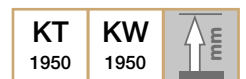

Descrizione Articolo Artikelbezeichnung Model description Descripción artículo	Articolo Artikel Model Código	Misura piatto doccia Tassenmaß Tray size Medidas del plato mm	Estensibilità Verstellbarkeit Adjustability Extensibilidad mm	Misura centro vetro Mitte Glasmaß Glass size middle Medida vidrio centro mm	Misura Maß Size Medidas mm		
					A	B	
<p>Porta basculante con sostegno Pendeltür mit Stütze Pivot door with support Puerta basculante con soporte</p> <p>IN OUT</p>	0070 KT	700	670 - 695	655 - 680	592	590	
	0075 KT	750	720 - 745	705 - 730	642	640	
	0080 KT	800	770 - 795	755 - 780	692	690	
	0082 KT		805 - 830	790 - 815	727	725	
	0090 KT	900	870 - 895	855 - 880	792	790	
	0092 KT		905 - 930	890 - 915	827	825	
	0100 KT	1000	970 - 995	955 - 980	892	890	
	0102 KT		1005 - 1030	990 - 1015	927	925	

<p>Laterale per porta basculante Seitenteil für Pendeltür Side panel for pivot door Pared lateral para puerta basculante</p>	0070 KW	700	670 - 695	655 - 680			
	0075 KW	750	720 - 745	705 - 730			
	0080 KW	800	770 - 795	755 - 780			
	0082 KW		803 - 828	788 - 813			
	0090 KW	900	870 - 895	855 - 880			
	0092 KW		903 - 928	888 - 913			
	0100 KW	1000	970 - 995	955 - 980			
	0102 KW		1003 - 1028	988 - 1013			
	0120 KW	1200	1170 - 1195	1155 - 1180			

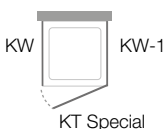

KOMBI KE-2

BOX ANGOLO PORTA CON FISSO

ECKEINSTIEG TÜR MIT FESTFELD

CORNER ENTRY DOOR WITH FIX PANEL

CABINA ANGULAR PUERTA CON FIJO

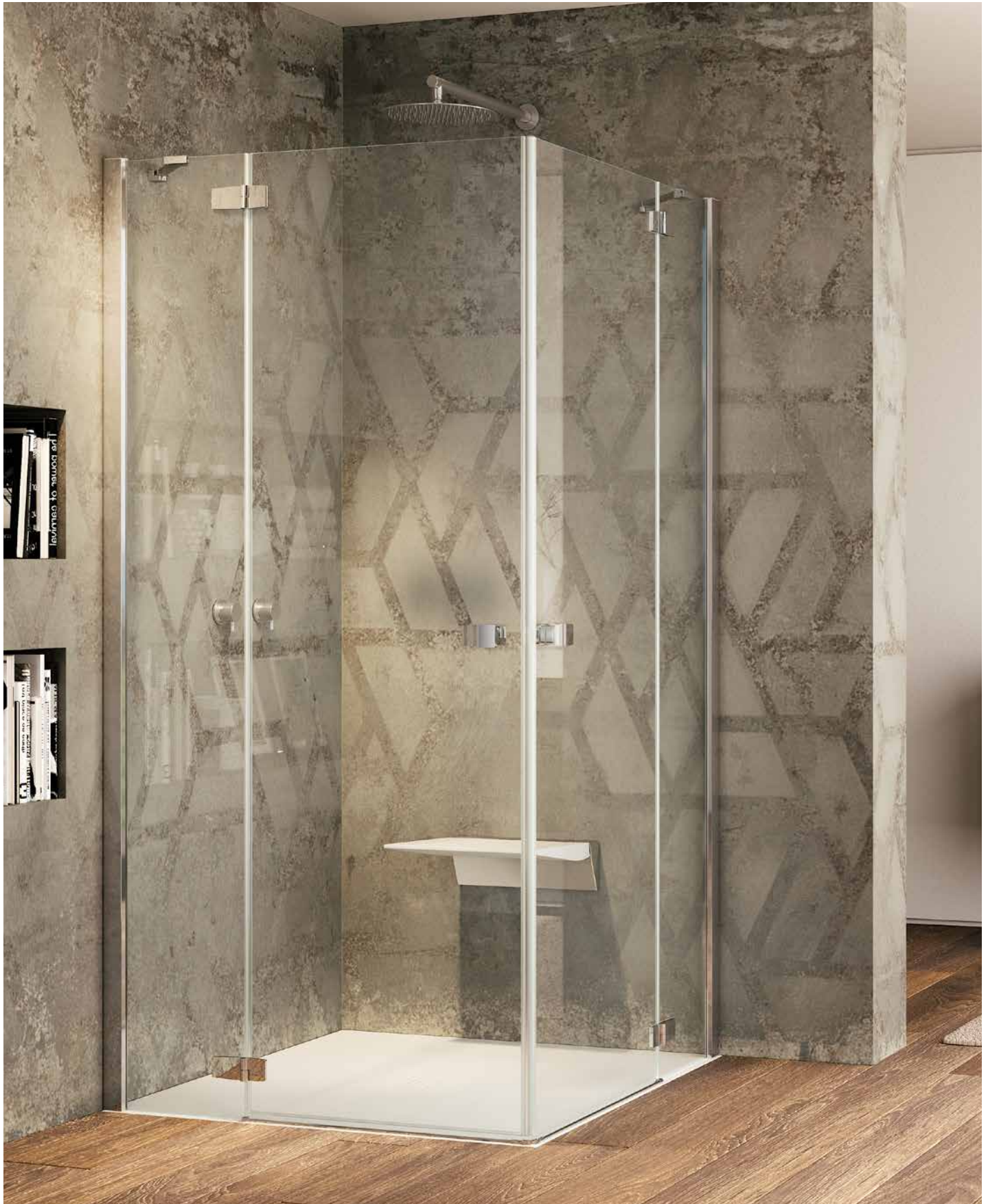



High
GLASS



KE-2
1950



GH
High
Glass

GL

6 mm

05

28

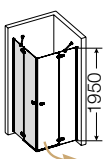

Descrizione Articolo Artikelbezeichnung Model description Descripción artículo	Articolo Artikel Model Código	Misura piatto doccia Tassenmaß Tray size Medidas del plato mm	Estensibilità Verstellbarkeit Adjustability Extensibilidad mm	Misura centro vetro Mitte Glasmaß Glass size middle Medida vidrio centro mm	Misura Maß Size Medidas mm		
					A	B	C
 <p>Box angolo porta con fisso* EckEinstieg Tür mit Festfeld* Corner entry door with fix panel* Cabinas angular puerta con fijo*</p>	2070 KE - L/R	700	670 - 695	655 - 680	600	250	440
	2075 KE - L/R	750	720 - 745	705 - 730	670	250	490
	2080 KE - L/R	800	770 - 795	755 - 780	740	250	540
	2082 KE - L/R		805 - 830	790 - 815	740	285	540
	2090 KE - L/R	900	870 - 895	855 - 880	885	250	640
	2092 KE - L/R		905 - 930	890 - 915	885	285	640
	2100 KE - L/R	1000	970 - 995	955 - 980	955	300	690
	2102 KE - L/R		1005 - 1030	990 - 1015	955	335	690
	2120 KE - L/R	1200	1170 - 1195	1155 - 1180	955	500	690
	2122 KE - L/R		1205 - 1230	1190 - 1215	955	535	690

*Usate 1 articolo cad. di KE-L e KE-R / Verwenden Sie je 1 x Artikel KE-L und KE-R / Use 1 article each KE-L and KE-R / Le rogamos de usar 1 cad. KE-L y KE-R

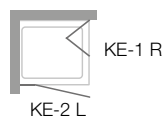
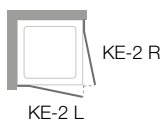

KE-2 L

KE-2 L

KOMBI **KT-2 + KW-2**

PORTA CON FISSO E SOSTEGNO + LATERALE

DREHTÜR MIT FESTFELD UND STÜTZE + SEITENTEIL

DOOR WITH FIX PANEL AND SUPPORT + SIDE PANEL

PUERTA CON FIJO Y SOPORTE + LATERAL

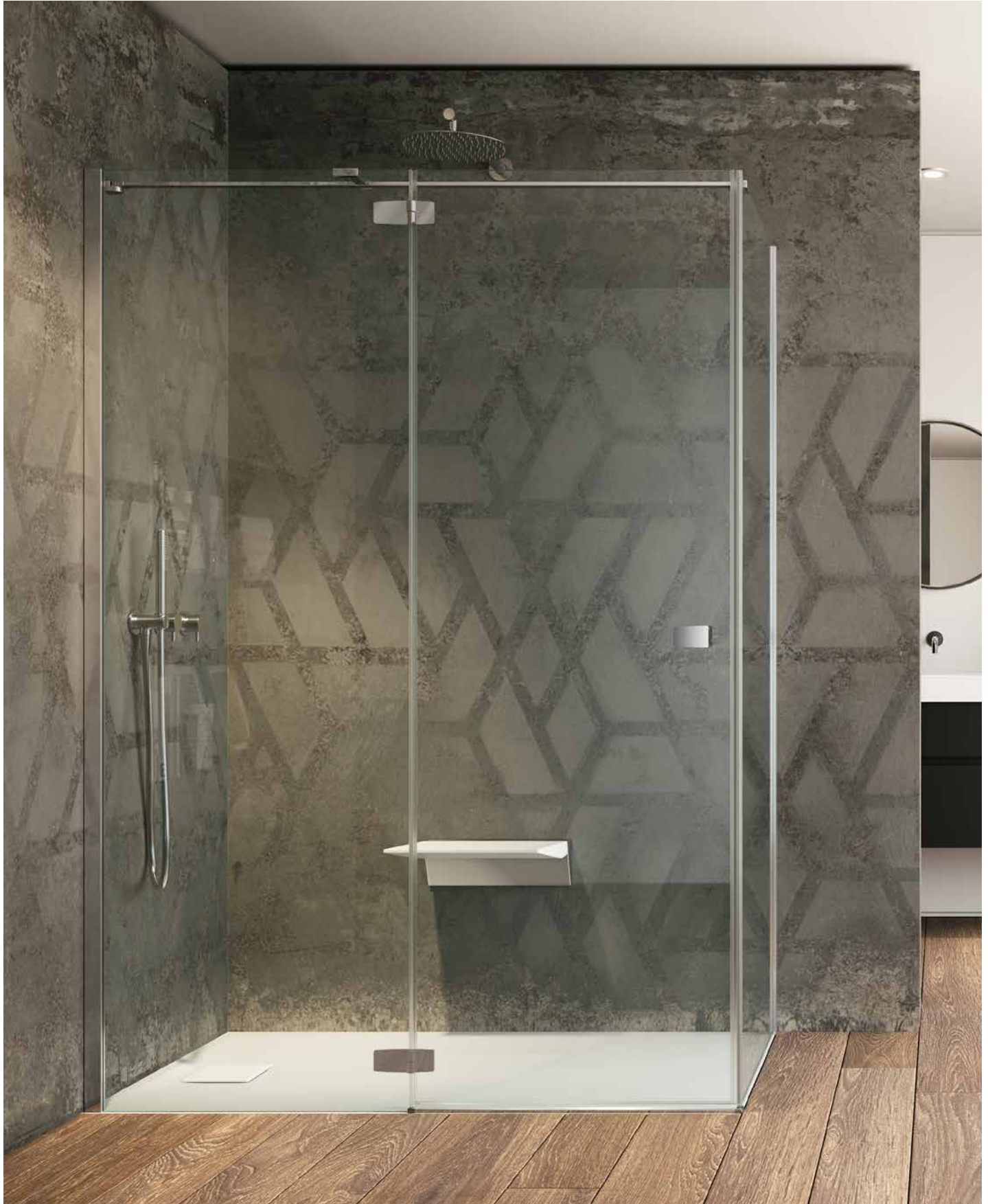



High
GLASS



KT-2 1950	KW-2 1950	
---------------------	---------------------	--

GH High Glass	GL	6 mm
----------------------------	-----------	-----------------

05	28	
-----------	-----------	--

Descrizione Articolo Artikelbezeichnung Model description Descripción artículo	Articolo Artikel Model Código	Misura piatto doccia Tassenmaß Tray size Medidas del plato mm	Estensibilità Verstellbarkeit Adjustability Extensibilidad mm	Misura centro vetro Mitte Glasmaß Glass size middle Medida vidrio centro mm	Misura Maß Size Medidas mm		
					A	B	C
<p>Porta con fisso e sostegno* Drehtür mit Festfeld und Stütze* Door with fix panel and support* Puerta con fijo y soporte*</p>	2070 KT - L/R	700	670 - 695	655 - 680	410	250	440
	2075 KT - L/R	750	720 - 745	705 - 730	460	250	490
	2080 KT - L/R	800	770 - 795	755 - 780	510	250	540
	2082 KT - L/R		805 - 830	790 - 815	510	285	540
	2090 KT - L/R	900	870 - 895	855 - 880	610	250	640
	2092 KT - L/R		905 - 930	890 - 915	610	285	640
	2100 KT - L/R	1000	970 - 995	955 - 980	660	300	690
	2102 KT - L/R		1005 - 1030	990 - 1015	660	335	690
	2120 KT - L/R	1200	1170 - 1195	1155 - 1180	660	500	690
	2122 KT - L/R		1205 - 1230	1190 - 1215	660	535	690

*Il lato di montaggio della cerniera da definire nell'ordine (sinistra L - destra R) / Montageseite des Scharniers bei Bestellung definieren (links L - rechts R)
Define the hinge assembly side when ordering (left L - right R) / Lado bisagra de la asamblea se indican en el pedido (izquierda L - derecha R)

<p>Laterale Seitenteil Side panel Pared lateral</p>	2070 KW	700	665 - 690	650 - 675			
	2075 KW	750	715 - 740	700 - 725			
	2080 KW	800	765 - 790	750 - 775			
	2082 KW		798 - 823	783 - 808			
	2090 KW	900	865 - 890	850 - 875			
	2092 KW		898 - 923	883 - 908			
	2100 KW	1000	965 - 990	950 - 975			
	2102 KW		998 - 1023	983 - 1008			
	2120 KW	1200	1165 - 1190	1150 - 1175			



KOMBI KR

BOX ROTONDO CON FISSO
RUNDKABINE MIT FESTFELD
SHOWER ENCLOSURE CUBICLE
CABINA SEMICIRCULAR CON FIJO





High
GLASS



KR
1950



GH
High
Glass

GL

6 mm

05

28



Descrizione Articolo Artikelbezeichnung Model description Descripción artículo	Articolo Artikel Model Código	Misura piatto doccia Tassenmaß Tray size Medidas del plato mm	Estensibilità Verstellbarkeit Adjustability Extensibilidad mm	Misura piatto installato Tasseneinbaumaß Tray installation measure Medidas del plato instalado mm	Misura Maß Size Medidas mm A B C
<p>Box rotondo con fisso* Rundkabine mit Festfeld* Shower enclosure cubicle* Cabina semicircular con fijo*</p>	6080 KR - L/R	800 R 550	775 - 800	785 - 810	748 255 410
	6090 KR - L/R	900 R 550	875 - 900	885 - 910	748 355 410
	6100 KR - L/R	1000 R 550	975 - 1000	985 - 1010	748 455 410

*Usate 1 articolo cad. di KR-L e KR-R / Verwenden Sie je 1 x Artikel KR-L und KR-R / Use 1 article each KR-L and KR-R / Le rogamos de usar 1 cad. KR-L y KR-R

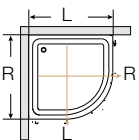

KR - L

KOMBI KS

BOX ROTONDO CON 1 PORTA PIVOTANTE

RUNDKABINE MIT 1 SCHWENKTÜR

SHOWER ENCLOSURE WITH 1 PIVOT DOOR

CABINA SEMICIRCULAR CON 1 PUERTA PIVOTANTE

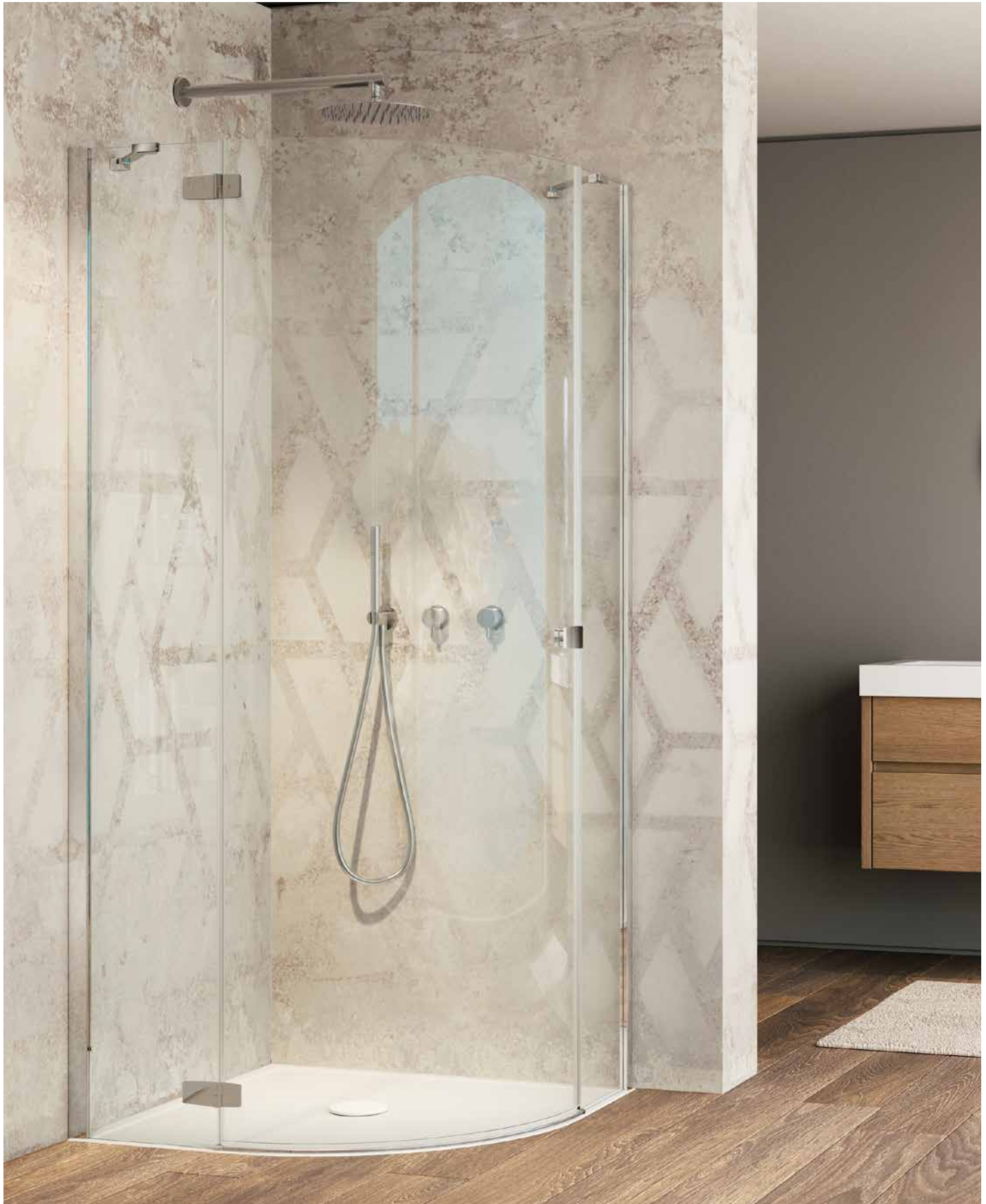



High
GLASS



KS
1950



GH
High
Glass

GL



05

28



Descrizione Articolo Artikelbezeichnung Model description Descripción artículo	Articolo Artikel Model Código	Misura piatto doccia Tassenmaß Tray size Medidas del plato mm		Estensibilità Verstellbarkeit Adjustability Extensibilidad mm		Misura Maß Size Medidas mm		
		L	R	L	R	A	B	C
 destra rechts right KS - R	6080 KS - R*	800 x	800 R 550	765 - 790	775 - 800	745	250	770
	6090 KS - R*	900 x	900 R 550	865 - 890	875 - 900	745	350	770
	6100 KS - R*	1000 x	1000 R 550	965 - 990	975 - 1000	745	450	770
	6809 KS - R*	800 x	900 R 550	765 - 790	875 - 900	745	250 / 350	770
	6901 KS - R*	900 x	1000 R 550	865 - 890	975 - 1000	745	350 / 450	770
	6109 KS - R*	1000 x	900 R 550	965 - 990	875 - 900	745	450 / 350	770

* Lato di cerniera / Gelenkseite / Hinge side

 sinistra links left KS - L	6080 KS - L*	800 x	800 R 550	775 - 800	765 - 790	745	250	770
	6090 KS - L*	900 x	900 R 550	875 - 900	865 - 890	745	350	770
	6100 KS - L*	1000 x	1000 R 550	975 - 1000	965 - 990	745	450	770
	6908 KS - L*	900 x	800 R 550	875 - 900	765 - 790	745	350 / 250	770
	6901 KS - L*	900 x	1000 R 550	875 - 900	965 - 990	745	350 / 450	770
	6109 KS - L*	1000 x	900 R 550	975 - 1000	865 - 890	745	450 / 350	770

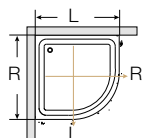

	6908 KS 6109 KS
	6809 KS 6901 KS

KOMBI KW-6

PARETE DOCCIA CON SOSTEGNO
RAUMABTRENNUNG MIT STÜTZE
SHOWER SCREEN WITH SUPPORT
SEPARA EL ESPACIO CON APOYO

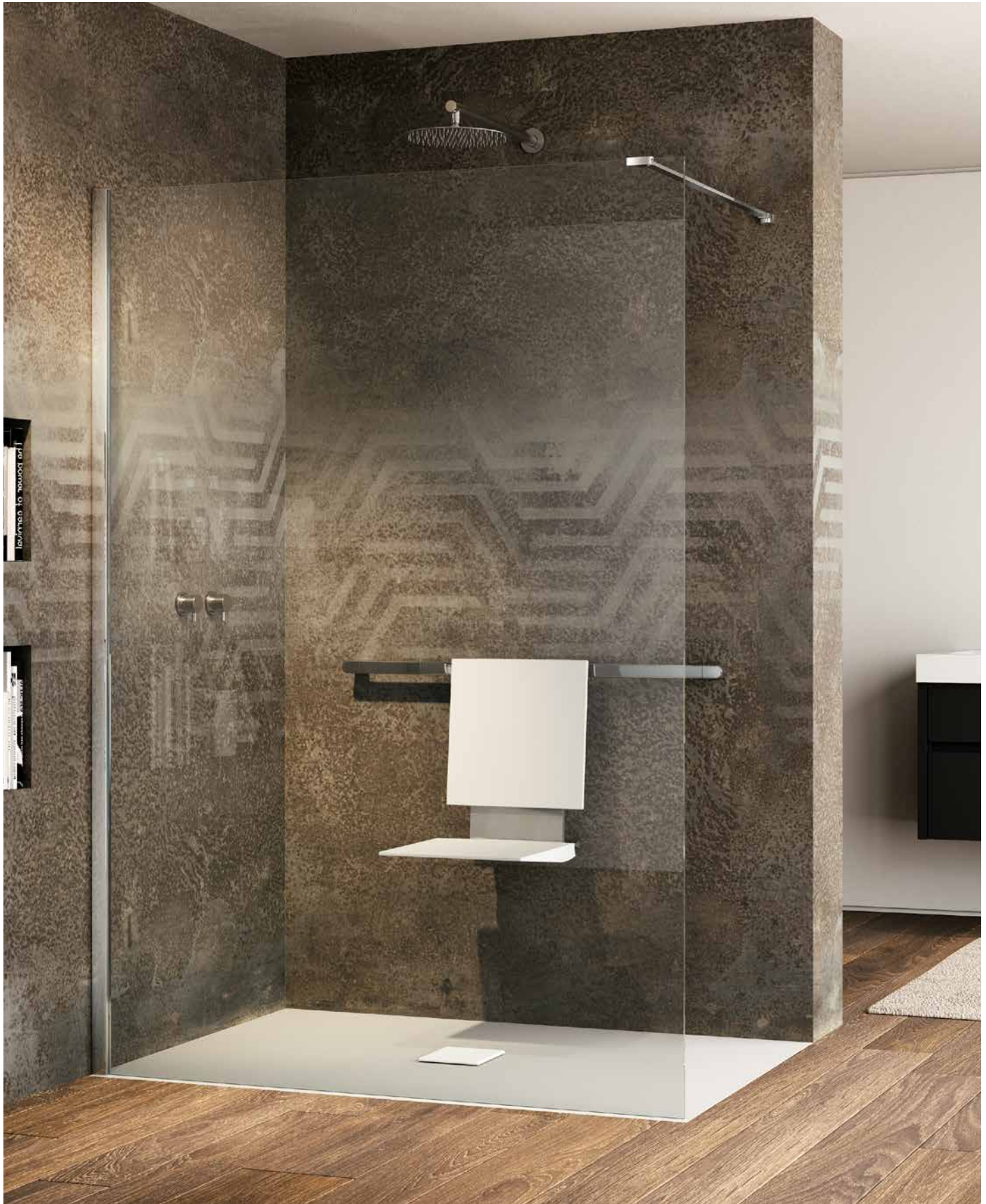

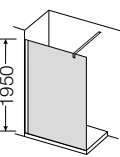

Descrizione Articolo Artikelbezeichnung Model description Descripción artículo	Articolo Artikel Model Código	Misura Maß Size Medidas mm A	Estensibilità Verstellbarkeit Adjustability Extensibilidad mm A B		Misura Maß Size Medidas mm A B
			A	B	
 <p>Parete doccia con sostegno Raumabtrennung mit Stütze Shower screen with support Separa el espacio con apoyo</p>	6100 KW	1000	980 - 1005	450 - 1200*	
	6120 KW	1200	1180 - 1205	450 - 1200*	
	6140 KW	1400	1380 - 1405	450 - 1200*	
	6017 KW	SPECIAL	600 - 1209	450 - 1200*	
	6079 KW	SPECIAL	1210 - 1410	450 - 1200*	

* Sostegno può essere montato anche a 45°/Stütze kann auch diagonal montiert werden/support can be installed diagonal/ Apoyo también puede ser montado en diagonal



Aggiungere all'ordine sempre disegno e misure (con/senza piatto doccia) esatte
Dem Auftrag immer Zeichnung und genaue Maße (mit/ohne Duschtasse) beifügen
Add to the order always drawing and exact sizes (with/without shower tray)
Siempre se deberá añadir al pedido, el dibujo y las medidas (con/sin plato de ducha)



KW-6

KW-6

KOMBI **KK-2**

ANTINA PER VASCA CON FISSO

KLAPPWAND MIT FIXTEIL

PIVOTING BATHTHSCREEN WITH FIX ELEMENT

HOJA PARA BAÑERA CON LATERAL

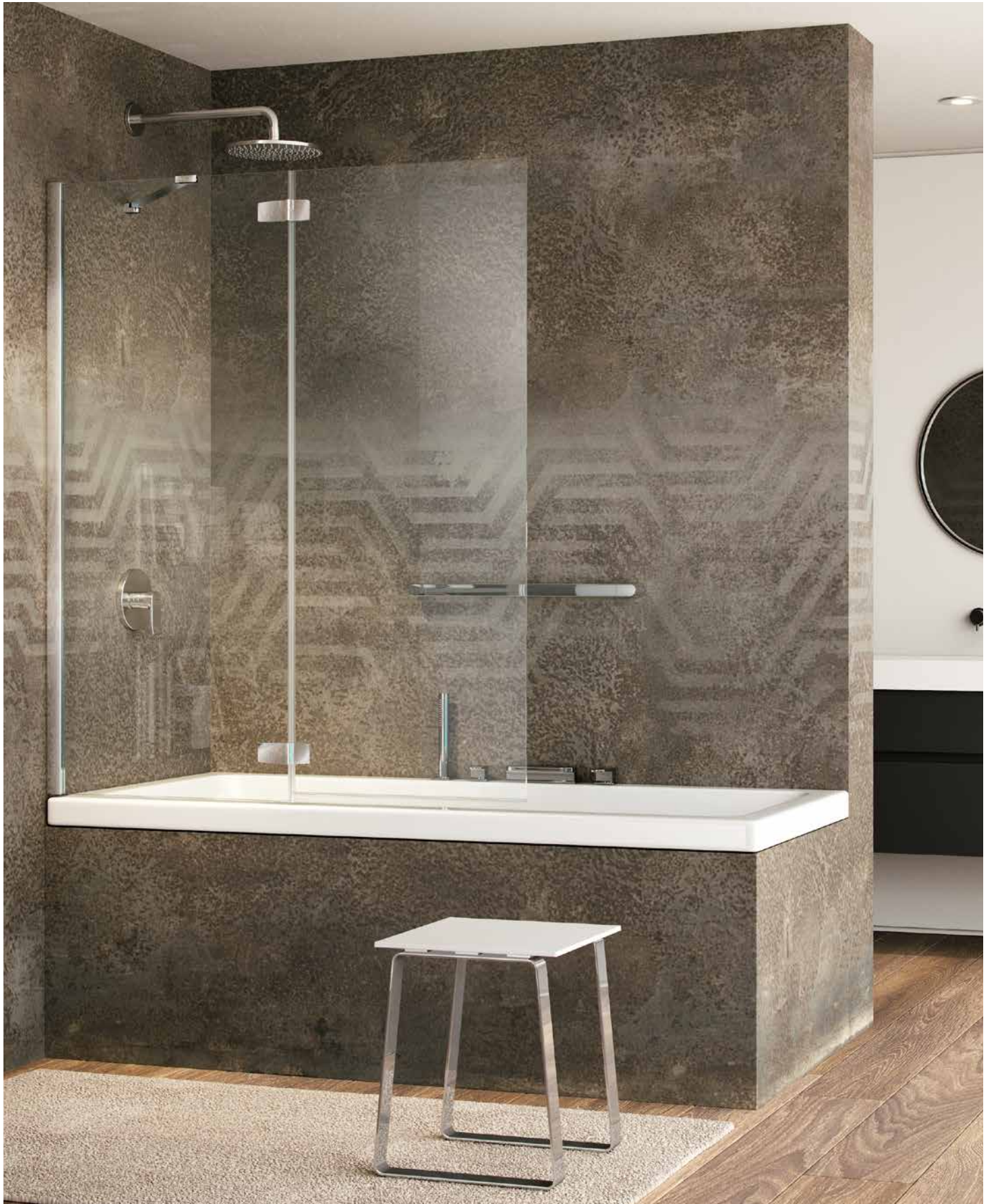



High
GLASS



KK-2
1400



GH
High
Glass

GL



05

28

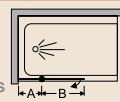
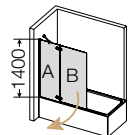

Descrizione Articolo Artikelbezeichnung Model description Descripción artículo	Articolo Artikel Model Código	Estensibilità Verstellbarkeit Adjustability Extensibilidad mm	Misura Maß Size Medidas mm	
				
			<p style="text-align: center;">A B</p>	
	<p>Antina per vasca con fisso* Klappwand mit Festfeld* Pivoting bathscreen with fix panel* Hoja para bañera con fijo*</p>	<p>2120 KK - L/R</p>	<p>1172 - 1197</p>	<p>635 555</p>

*Il lato di montaggio da definire nell'ordine (sinistra L - destra R) / Montageseite bei Bestellung definieren (links L - rechts R)
Define the assembly side when ordering (left L - right R) / Lado de la asamblea se indican en el pedido (izquierda L - derecha R)

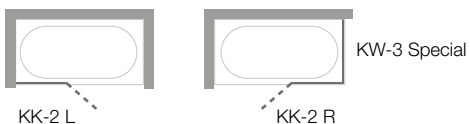

KOMBI FREE KN-1 + KB

PORTA SOFFIETTO + LATERALE PER VASCA

FALTTÜR + SEITENTEIL FÜR BADEWANNE

BI-FOLD DOOR + SIDE PANEL FOR BATHTUB

PUERTA PLEGABLE + LATERAL PARA BAÑERA

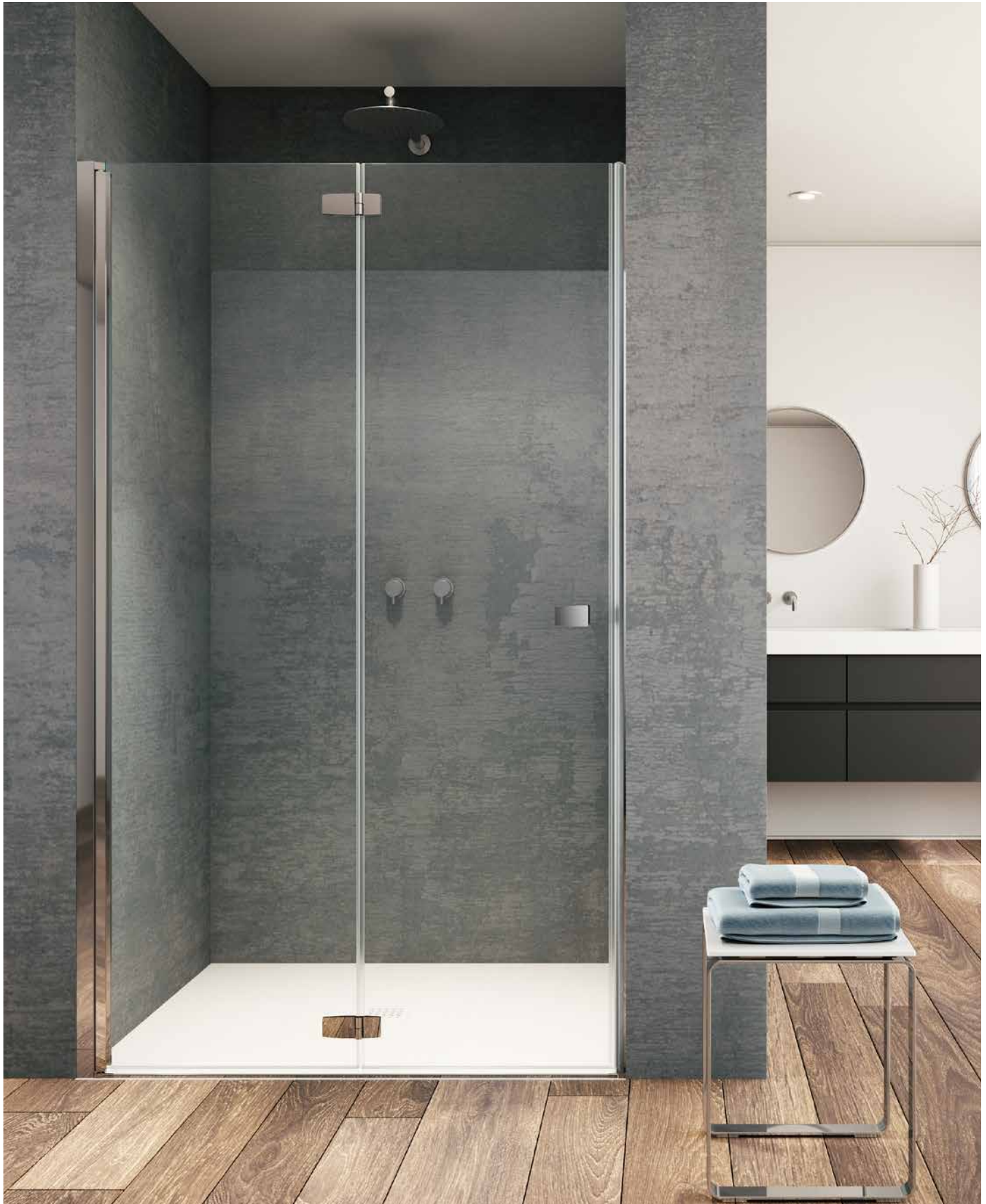



High
GLASS



KN-1 **KB**
1950 max 1800



GH **GL** 6 mm
High Glass

05 **28**

Descrizione Articolo Artikelbezeichnung Model description Descripción artículo	Articolo Artikel Model Código	Misura piatto doccia Tassenmaß Tray size Medidas del plato mm	Estensibilità Verstellbarkeit Adjustability Extensibilidad mm	Estensibilità laterale Verstellbarkeit Seitenteil Adjustability side panel Extensibilidad lateral mm	Misura Maß Size Medidas mm			
					A	B	C	
<p>Porta soffietto* Pendel-Falttür* Bi-fold door* Puerta plegable*</p>								
	IN	1070 KN - L/R	700	670 - 705		592	80	325
	OUT	1075 KN - L/R	750	720 - 755		642	80	350
		1080 KN - L/R	800	770 - 805		692	80	375
		1090 KN - L/R	900	870 - 905		792	80	425
		1100 KN - L/R	1000	970 - 1005		892	80	475
	1120 KN - L/R	1200	1170 - 1205		1092	80	575	

*Il lato di montaggio della cerniera murale da definire nell'ordine (sinistra L - destra R) / Montageseite des Wandscharniers bei Bestellung definieren (links L - rechts R)
Define the hinge assembly side when ordering (left L - right R) / Lado bisagra de la asamblea se indican en el pedido (izquierda L - derecha R)

<p>Laterale per vasca Seitenteil für Badewanne Side panel for bathtub Pared lateral para bañera</p>	Articolo Artikel Model Código	Misura piatto doccia Tassenmaß Tray size Medidas del plato mm	Estensibilità Verstellbarkeit Adjustability Extensibilidad mm	Estensibilità laterale Verstellbarkeit Seitenteil Adjustability side panel Extensibilidad lateral mm	Misura Maß Size Medidas mm		
					A	B	C
	0015 KB**	700 - 1000		25			

** Articolo é sempre un fuori misura / Artikel ist immer Sondermaß / article is always special measure / artículo es siempre medida especial

<p>Indicare sempre bordo piatto fino bordo vasca/muretto Oberkante Duschtasse bis Badewanne/Mauer immer angeben Indicate always shower tray to bathtub panel/wall Indique siempre borde superior plato de ducha y bañera/muro</p>
--



KOMBI FREE KI-4

PORTA SOFFIETTO DOPPIA IN LINEA
PENDEL-FALTTÜR DOPPELT IN LINIE
BI-FOLD DOUBLE DOOR INLINE
PUERTA PLEGABLE DOBLE EN LINEA

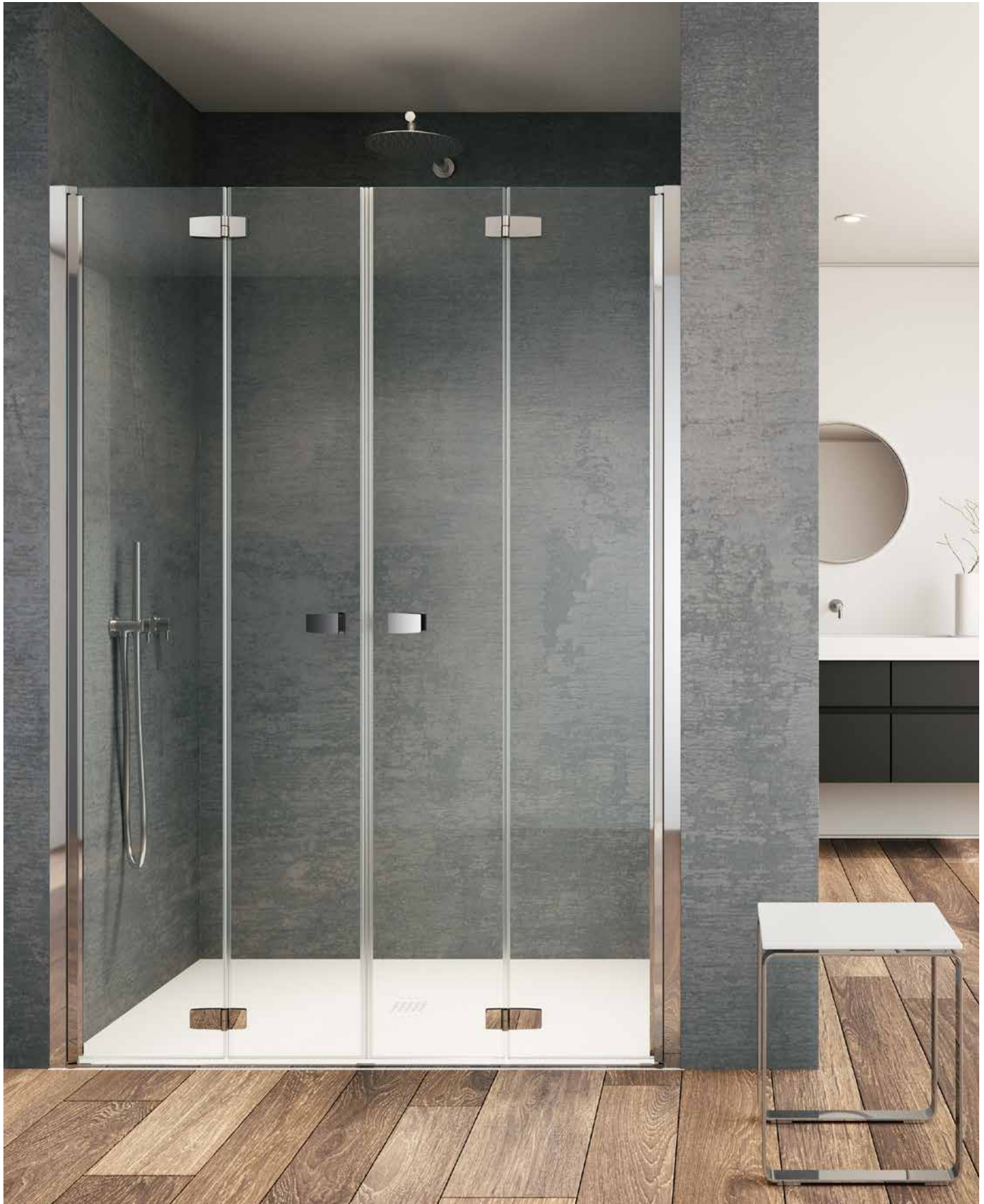



High
GLASS



KI-4
1950



GH High Glass GL 6 mm

05 28

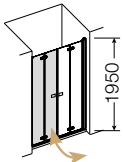
Descrizione Articolo Artikelbezeichnung Model description Descripción artículo	Articolo Artikel Model Código	Misura piatto doccia Tassenmaß Tray size Medidas del plato mm	Estensibilità Verstellbarkeit Adjustability Extensibilidad mm	Misura Maß Size Medidas mm		
				A	B	C
 <p>Porta soffietto in linea* Pendel-Faltrittür in Linie* Bi-fold door in-line* Puerta plegable en línea*</p>	4120 KI - L/R	1200	1173 - 1223	1060	80	275
	4130 KI - L/R	1300	1273 - 1323	1160	80	325
	4140 KI - L/R	1400	1373 - 1423	1260	80	325

*Usate 1 articolo cad. di KI-L e KI-R / Verwenden Sie je 1 x Artikel KI-L und KI-R / Use 1 article each KI-L and KI-R / Le rogamos de usar 1 cad. KI-L y KI-R



KOMBI FREE KE-1

BOX AD ANGOLO PIEGHEVOLE
ECKEINSTIEG KLAPPBAR
FOLDING CORNER ENTRY
CABINA ANGULAR PLEGABLE





High
GLASS



KE-1
1950

GH High Glass GL 6mm

05 28

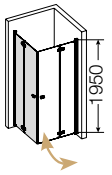
Descrizione Articolo Artikelbezeichnung Model description Descripción artículo	Articolo Artikel Model Código	Misura piatto doccia Tassenmaß Tray size Medidas del plato mm	Estensibilità Verstellbarkeit Adjustability Extensibilidad mm	Misura centro vetro Mitte Glasmaß Glass size middle Medida vidrio centro mm	Misura Maß Size Medidas mm		
					A	B	C
 <p>Box ad angolo pieghevole* EckEinstieg klappbar* Folding corner entry* Cabina angular plegable*</p>	1070 KE - L/R	700	665 - 690	650 - 675	830	80	325
	1075 KE - L/R	750	715 - 740	700 - 725	905	80	350
	1080 KE - L/R	800	765 - 790	750 - 775	975	80	375
	1082 KE - L/R		800 - 825	785 - 810	1025	80	410
	1090 KE - L/R	900	865 - 890	850 - 875	1115	80	425
	1092 KE - L/R		900 - 925	885 - 910	1165	80	460
	1100 KE - L/R	1000	965 - 990	950 - 975	1260	80	475
	1102 KE - L/R		1000 - 1025	985 - 1010	1305	80	510
	1120 KE - L/R	1200	1165 - 1190	1150 - 1175	1540	80	575
	1122 KE - L/R		1200 - 1225	1185 - 1210	1590	80	610

*Usate 1 articolo cad. di KE-L e KE-R / Verwenden Sie je 1 x Artikel KE-L und KE-R / Use 1 article each KE-L and KE-R / Le rogamos de usar 1 cad. KE-L y KE-R

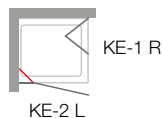
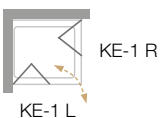

KOMBI FREE **KT-1 + KW**

PORTA SOFFIETTO CON LATERALE
FALTTÜR MIT SEITENTEIL
BI-FOLD DOOR WITH SIDE PANEL
PUERTA PLEGABLE CON LATERAL





High
GLASS



KT-1 **KW**
1950 1950



GH **GL** **6 mm**
High Glass



05 **28**



Descrizione Articolo Artikelbezeichnung Model description Descripción artículo	Articolo Artikel Model Código	Misura piatto doccia Tassenmaß Tray size Medidas del plato mm	Estensibilità Verstellbarkeit Adjustability Extensibilidad mm	Misura centro vetro Mitte Glasmaß Glass size middle Medida vidrio centro mm	Misura Maß Size Medidas mm			
					A	B	C	
 <p>Porta soffietto * Pendel-Faltrittür * Bi-fold door * Puerta plegable *</p>								
	IN	1070 KT - L/R	700	667 - 692	652 - 677	592	80	325
	OUT	1075 KT - L/R	750	717 - 742	702 - 727	642	80	350
		1080 KT - L/R	800	767 - 792	752 - 777	692	80	375
		1082 KT - L/R		802 - 827	787 - 812	727	80	410
		1090 KT - L/R	900	867 - 892	852 - 877	792	80	425
		1092 KT - L/R		902 - 927	887 - 912	827	80	460
		1100 KT - L/R	1000	967 - 992	952 - 977	892	80	475
		1102 KT - L/R		1002 - 1027	987 - 1012	927	80	510
		1120 KT - L/R	1200	1167 - 1192	1152 - 1177	1092	80	575
		1122 KT - L/R		1202 - 1227	1187 - 1212	1127	80	610

*Il lato di montaggio della cerniera murale da definire nell'ordine (sinistra L - destra R) / Montageseite des Wandscharniers bei Bestellung definieren (links L - rechts R)
Define the hinge assembly side when ordering (left L - right R) / Lado bisagra de la asamblea se indican en el pedido (izquierda L - derecha R)

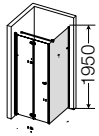
 <p>Laterale con sostegno Seitenteil mit Stütze Side panel with support Pared lateral con soporte</p>	0070 KW	700	670 - 695	655 - 680			
	0075 KW	750	720 - 745	705 - 730			
	0080 KW	800	770 - 795	755 - 780			
	0082 KW		803 - 828	788 - 813			
	0090 KW	900	870 - 895	855 - 880			
	0092 KW		903 - 928	888 - 913			
	0100 KW	1000	970 - 995	955 - 980			
	0102 KW		1003 - 1028	988 - 1013			
	0120 KW	1200	1170 - 1195	1155 - 1180			



KOMBI FREE KW-5

PARETE DOCCIA PIEGHEVOLE
RAUMABTRENNUNG PENDEL-FALTTÜR
SHOWER SCREEN PIVOTING
SEPARA EL ESPACIO PIVOTANTE





High
GLASS



KW-5
1950



GH
High
Glass

GL

6 mm

05

28

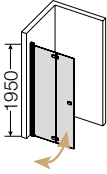

Descrizione Articolo Artikelbezeichnung Model description Descripción artículo	Articolo Artikel Model Código	Misura	Estensibilità	Misura	
		Maß Size Medidas mm	Verstellbarkeit Adjustability Extensibilidad mm	Maß Size Medidas mm	Maß Size Medidas mm
		A	A	B	C
 <p>Parete doccia pieghevole * Raumabtrennung Pendel-Falttür * Shower screen pivoting * Separa el espacio pivotante *</p>	5080 KW - L/R	800	775 - 800	80	410
	5090 KW - L/R	900	875 - 900	80	460
	5100 KW - L/R	1000	975 - 1000	80	510
	5120 KW - L/R	1200	1175 - 1200	80	610

IN
OUT

*Il lato di montaggio della cerniera murale da definire nell'ordine (sinistra L - destra R) / Montageseite des Wandscharniers bei Bestellung definieren (links L - rechts R)
Define the hinge assembly side when ordering (left L - right R) / Lado bisagra de la asamblea se indican en el pedido (izquierda L - derecha R)



KW-5 L



KW-5 R

KOMBI FREE **KK-1**

ANTINA PER VASCA A 2 ANTE PIEGHEVOLE

2-TEILIGE KLAPPWAND

DOUBLE PIVOTING BATHTHSCREEN

HOJA PARA BAÑERA 2 ELEMENTOS





High
GLASS



KK-1
1400



GH
High
Glass

GL

6 mm



05

28



Descrizione Articolo Artikelbezeichnung Model description Descripción artículo	Articolo Artikel Model Código	Misura vasca Wannenmaß Bathtub size Medidas de la bañera mm C	Estensibilità Verstellbarkeit Adjustability Extensibilidad mm	Misura Maß Size Medidas mm A B
 <p>IN OUT</p> <p>Antina per vasca a 2 ante pieghevole* 2-teilige Klappwand* Double pivoting bathscreen* Hoja para bañera 2 elementos*</p>	1120 KK - L/R	650 min.	1200 - 1225	665 555

*Il lato di montaggio da definire nell'ordine (sinistra L - destra R) / Montageseite bei Bestellung definieren (links L - rechts R)
Define the assembly side when ordering (left L - right R) / Lado de la asamblea se indican en el pedido (izquierda L - derecha R)

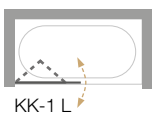

KK-1 L

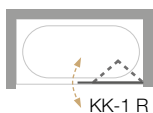

KK-1 R