

E-LITE/E-LITE FREE

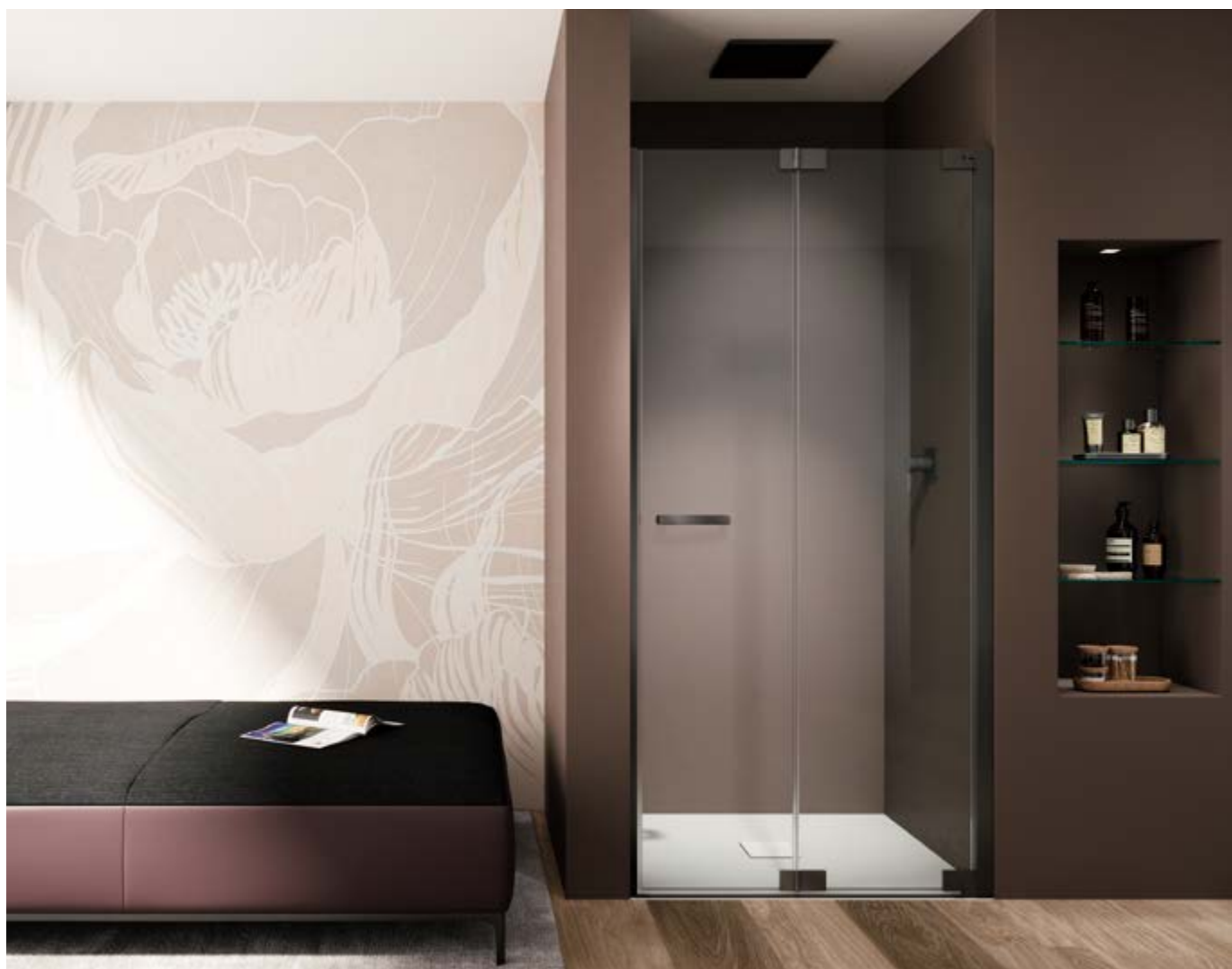

PLANNING CREATIVITY WITH
THE SEARCH FOR NEW
MATERIALS AND FORMS

PROVEX
comfort in the bathroom

INDICE E-LITE
 INHALT E-LITE
 INDEX E-LITE
 INDICE E-LITE

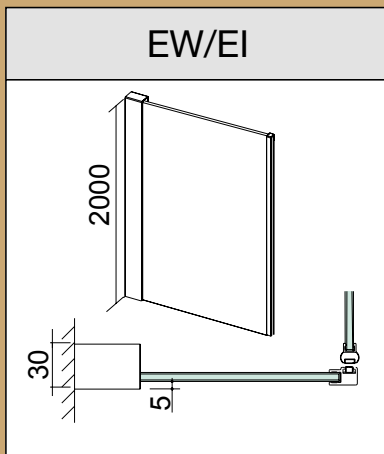
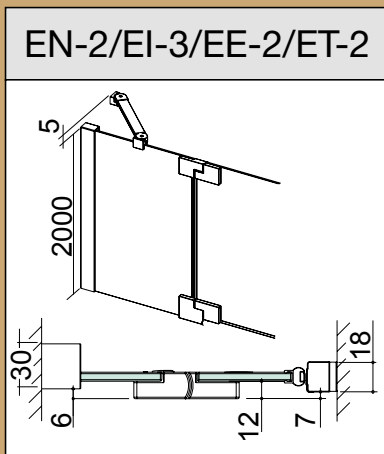
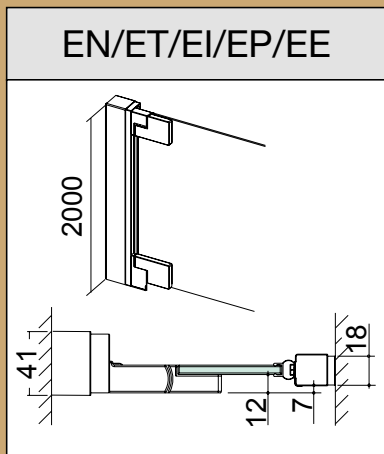
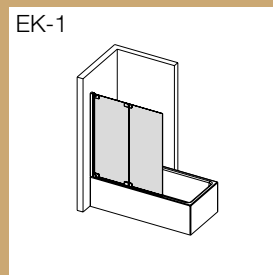
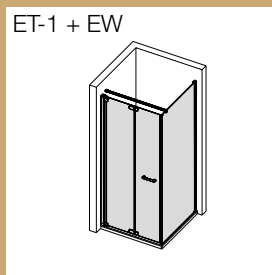
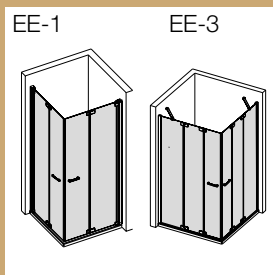
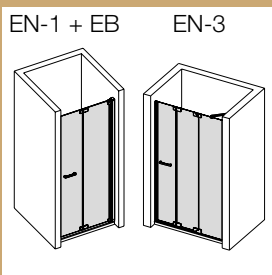
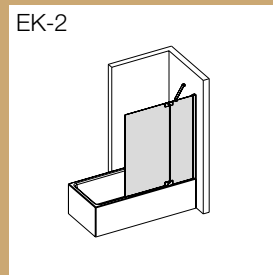
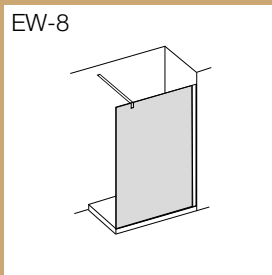
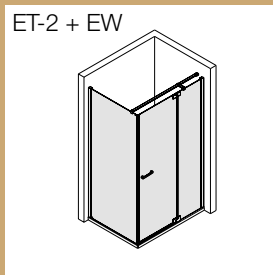
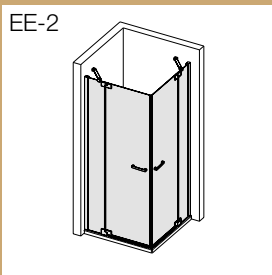
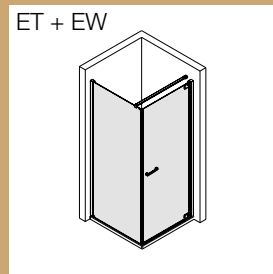
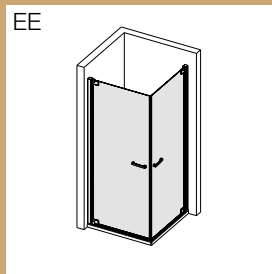
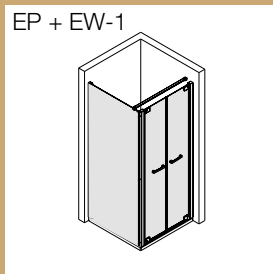
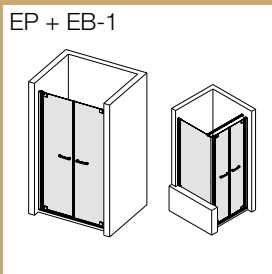
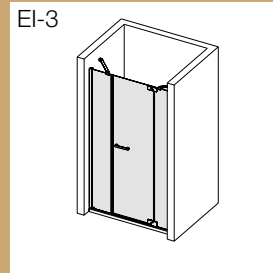
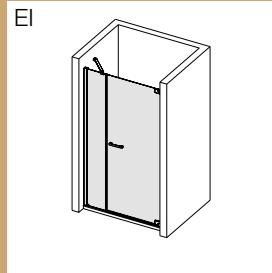
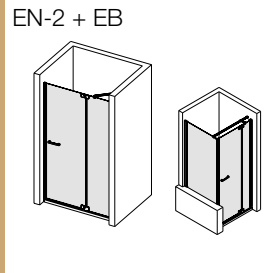
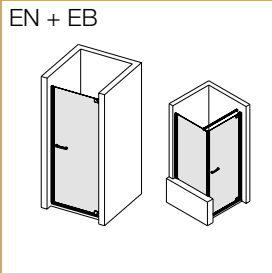



BOX DOCCIA CON TECNICA A CERNIERA

- Design Studio Talocci + Pallocca
- Cerniera basculante IN/OUT fino a 270°
- **MinMax** – il sistema innovativo con un'estensibilità fino a 90 mm
- Viti planari all'interno del box per una pulizia semplice e profonda
- Altezza vetro e profilo uniforme di 2000 mm
- Regolazione di precisione e aggiustamento postumo di tutti gli elementi
- Profilo a parete senza bisogno di silicone
- Porte con meccanismo di sollevamento/abbassamento sempre attivo



DUSCHKABINEN MIT SCHARNIERTECHNIK

- Design Studio Talocci + Pallocca
- Pendelscharnier IN/OUT bis zu 270°
- **MinMax** – das innovative System mit bis zu 90 mm Verstellbereich
- Scharnierschrauben sind für eine einfache Reinigung im Glas versenkt
- Einheitliche Glas- und Profilhöhe 2000 mm
- Stufenlose Feineinstellung und Nachadjustierung aller Elemente
- Silikonfreier Wandanschluss
- Türelemente mit aktivem Hebe- Senkmechanismus



SHOWER ENCLOSURE WITH HINGE TECHNOLOGY

- Design Studio Talocci + Pallocca
- Saloon door hinges IN/OUT up to 270°
- **MinMax** – the innovative system with adjustment up to 90 mm
- Hinge screws are sunken into the glass to simplify the cleaning
- Uniform glass and profile height 2000 mm
- Infinitely micro- and re-adjustment of all elements
- Silicone free wall junction
- Door elements with active up and down lifting mechanism



MAMPARAS DE DUCHA CON TECNOLOGÍA DE BISAGRA

- Design Studio Talocci + Pallocca
- Bisagra basculante IN/OUT hasta 270°
- **MinMax** – un sistema innovador con una extensibilidad de 90 mm
- Tornillos planos en el interior de la cabina para facilitar la limpieza
- Altura vidrio y perfil uniforme 2000 mm
- Regulación extrema en el ajustamento de todos los elementos
- Fijación a pared sin necesidad de silicona
- Puertas con mecanismo de levantamiento/descenso permanente

E-LITE EN + EB

PORTA BASCULANTE + LATERALE PER VASCA
PENDELTÜR 1-TEILIG + SEITENTEIL FÜR BADEWANNE
PIVOT DOOR + SIDE PANEL FOR BATHTUB
PUERTA BASCULANTE + LATERAL PARA BAÑERA





High
GLASS



EN 2000 **EB** max 1800

GH High Glass **GL** 6 mm

05 **10**

Descrizione Articolo Artikelbezeichnung Model description Descripción artículo	Articolo Artikel Model Código	Misura piatto doccia Tassenmaß Tray size Medidas del plato mm	Estensibilità Verstellbarkeit Adjustability Extensibilidad mm	Misura Maß Size Medidas mm	
				A	B
<p>Porta basculante* Pendeltür 1-teilig* Pivot door* Puerta basculante*</p> <p>IN OUT</p>	0070 EN - L/R	700	670 - 705	565	570
	0075 EN - L/R	750	720 - 755	615	620
	0080 EN - L/R	800	770 - 805	665	670
	0090 EN - L/R	900	870 - 905	765	770
	0100 EN - L/R	1000	970 - 1005	865	870

*Il lato di montaggio della cerniera da definire nell'ordine (sinistra L - destra R) / Montageseite des Scharniers bei Bestellung definieren (links L - rechts R)
Define the hinge assembly side when ordering (left L - right R) / Lado bisagra de la asamblea se indican en el pedido (izquierda L - derecha R)

<p>Laterale per vasca Seitenteil für Badewanne Side panel for bathtub Pared lateral para bañera</p>	0015 EB**	700 - 1000	25			

** Articolo é sempre un fuori misura / Artikel ist immer Sondermaß / article is always special measure / artículo es siempre medida especial

Indicare sempre bordo piatto fino bordo vasca/muretto
Oberkante Duschtasse bis Badewanne/Mauer immer angeben
Indicate always shower tray to bathtub panel/wall
Indique siempre borde superior plato de ducha y bañera/muro



E-LITE EN-2 + EB

PORTA BASCULANTE CON FISSO + LATERALE PER VASCA
PENDELTÜR MIT FESTFELD + SEITENTEIL FÜR BADEWANNE
PIVOT DOOR WITH FIX PANEL + SIDE PANEL FOR BATHTUB
PUERTA BASCULANTE CON FIJO + LATERAL PARA BAÑERA





High GLASS



EN-2 EB
2000 max 1800

GH GL 6mm
High Glass

05 10

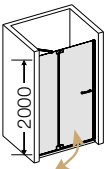
Descrizione Articolo Artikelbezeichnung Model description Descripción artículo	Articolo Artikel Model Código	Misura piatto doccia Tassenmaß Tray size Medidas del plato mm	Estensibilità Verstellbarkeit Adjustability Extensibilidad mm MINMAX	Misura Maß Size Medidas mm		
				A	B	C
 <p>Porta basculante con fisso* Pendeltür mit Festfeld* Pivot door with fix panel* Puerta basculante con fijo*</p>	2090 EN - L/R	900	870 - 925	565	305	570
	2100 EN - L/R	1000	970 - 1025	665	305	670
	2110 EN - L/R	1100	1070 - 1125	665	405	670
	2120 EN - L/R	1200	1170 - 1225	665	505	670
	2140 EN - L/R	1400	1370 - 1425	665	705	670

*Il lato di montaggio della cerniera da definire nell'ordine (sinistra L - destra R) / Montageseite des Scharniers bei Bestellung definieren (links L - rechts R)
Define the hinge assembly side when ordering (left L - right R) / Lado bisagra de la asamblea se indican en el pedido (izquierda L - derecha R)

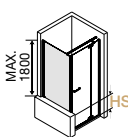
 <p>Laterale per vasca Seitenteil für Badewanne Side panel for bathtub Pared lateral para bañera</p>	0015 EB**	700 - 1000	25			

** Articolo é sempre un fuori misura / Artikel ist immer Sondermaß / article is always special measure / artículo es siempre medida especial

Indicare sempre bordo piatto fino bordo vasca/muretto
Oberkante Duschtasse bis Badewanne/Mauer immer angeben
Indicate always shower tray to bathtub panel/wall
Indique siempre borde superior plato de ducha y bañera/muro

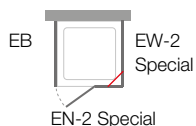
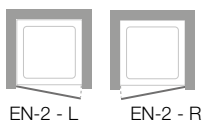

E-LITE EI

PORTA BASCULANTE IN LINEA
PENDELTÜR IN LINIE
PIVOT DOOR WITH IN-LINE PANEL
PUERTA BASCULANTE EN LINEA



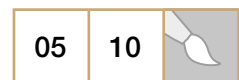

Descrizione Articolo Artikelbezeichnung Model description Descripción artículo	Articolo Artikel Model Código	Misura piatto doccia Tassenmaß Tray size Medidas del plato mm	Estensibilità Verstellbarkeit Adjustability Extensibilidad mm MINMAX	Misura Maß Size Medidas mm		
				A	B	C
 <p>Porta basculante in linea* Pendeltür in Linie* Pivot door with in-line panel* Puerta basculante en línea*</p>	0100 EI - L/R	1000	953 - 1023	325	565	570
	0110 EI - L/R	1100	1053 - 1123	325	665	670
	0120 EI - L/R	1200	1153 - 1223	325	765	770
	0140 EI - L/R	1400	1353 - 1423	525	765	770
	0160 EI - L/R	1600	1553 - 1623	725	765	770

*Il lato di montaggio della cerniera da definire nell'ordine (sinistra L - destra R) / Montageseite des Scharniers bei Bestellung definieren (links L - rechts R)
Define the hinge assembly side when ordering (left L - right R) / Lado bisagra de la asamblea se indican en el pedido (izquierda L - derecha R)

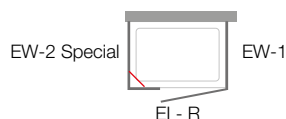

E-LITE EI-3

PORTA BASCULANTE CON FISSI IN LINEA
PENDELTÜR MIT FESTFELDERN IN LINIE
PIVOT DOOR WITH IN-LINE FIX PANELS
PUERTA BASCULANTE CON FIJOS EN LINEA



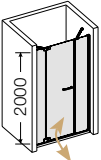

Descrizione Articolo Artikelbezeichnung Model description Descripción artículo	Articolo Artikel Model Código	Misura piatto doccia Tassenmaß Tray size Medidas del plato mm	Estensibilità Verstellbarkeit Adjustability Extensibilidad mm MIN MAX	Misura Maß Size Medidas mm			
				A	B	C	D
 <p>Porta con fissi in linea* Tür mit Festfeldern in Linie* Door with in-line fix panels* Puerta con fijos*</p>	3120 EI - L/R	1200	1153 - 1243	325	565	570	305
	3140 EI - L/R	1400	1353 - 1443	325	665	670	405
	3160 EI - L/R	1600	1553 - 1643	525	765	670	405

*Il lato di montaggio della cerniera da definire nell'ordine (sinistra L - destra R) / Montageseite des Scharniers bei Bestellung definieren (links L - rechts R)
Define the hinge assembly side when ordering (left L - right R) / Lado bisagra de la asamblea se indican en el pedido (izquierda L - derecha R)

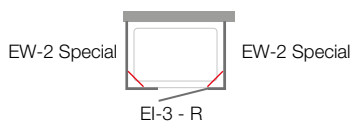

E-LITE EP + EB-1

PORTA SALOON + LATERALE PER VASCA

PENDELTÜR 2-TEILIG + SEITENTEIL FÜR BADEWANNE

SALOON DOOR + SIDE PANEL FOR BATHTUB

PUERTA BASCULANTE DOPPIA + LATERAL PARA BAÑERA





EP 2000	EB-1 max 1800	
-------------------	-------------------------	--

GH High Glass	GL	6 mm
-------------------------	-----------	-----------------

05	10	
-----------	-----------	--

Descrizione Articolo Artikelbezeichnung Model description Descripción artículo	Articolo Artikel Model Código	Misura piatto doccia Tassenmaß Tray size Medidas del plato mm	Estensibilità Verstellbarkeit Adjustability Extensibilidad mm	Misura Maß Size Medidas mm		
				A	B	
 Porta saloon Pendeltür 2-teilig Saloon door Puerta basculante	0070 EP	700	658 - 708	490	250	
	0075 EP	750	708 - 758	540	275	
	0080 EP	800	758 - 808	590	300	
	0090 EP	900	858 - 908	690	350	
	0100 EP	1000	958 - 1008	790	400	
	0120 EP	1200	1158 - 1208	990	500	
 Laterale per vasca Seitenteil für Badewanne Side panel for bathtub Pared lateral para bañera	1015 EB*	700 - 1000	25			

* Articolo é sempre un fuori misura / Artikel ist immer Sondermaß / article is always special measure / artículo es siempre medida especial

	Indicare sempre bordo piatto fino bordo vasca/muretto Oberkante Duschtasse bis Badewanne/Mauer immer angeben Indicate always shower tray to bathtub panel/wall Indique siempre borde superior plato de ducha y bañera/muro
--	--

E-LITE EP + EW-1

PORTA SALOON CON LATERALE

PENDELTÜR 2-TEILIG MIT SEITENTEIL

SALOON DOOR WITH SIDE PANEL

PUERTA BASCULANTE DOPPIA CON LATERAL



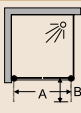
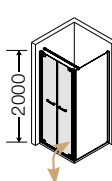
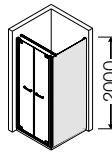

Descrizione Articolo Artikelbezeichnung Model description Descripción artículo	Articolo Artikel Model Código	Misura piatto doccia Tassenmaß Tray size Medidas del plato mm	Estensibilità Verstellbarkeit Adjustability Extensibilidad mm MINMAX	Misura centro vetro Mitte Glasmaß Glass size middle Medida vidrio centro mm	Misura Maß Size Medidas mm		
					A	B	
 <p>Porta saloon Pendeltür 2-teilig Saloon door Puerta basculante</p>							
	0070 EP	700	675 - 725	668 - 718	490	250	
	0075 EP	750	725 - 775	718 - 768	540	275	
	0080 EP	800	775 - 825	768 - 818	590	300	
	0090 EP	900	875 - 925	868 - 918	690	350	
	0100 EP	1000	975 - 1025	968 - 1018	790	400	
	0120 EP	1200	1175 - 1225	1168 - 1218	990	500	
 <p>Laterale per porta basculante Seitenteil für Pendeltür Side panel for saloon door Lateral para puerta basculante</p>							
	1070 EW	700	675 - 720	660 - 705			
	1075 EW	750	725 - 770	710 - 755			
	1080 EW	800	775 - 820	760 - 805			
	1082 EW		795 - 840	780 - 825			
	1090 EW	900	875 - 920	860 - 905			
	1092 EW		895 - 940	880 - 925			
	1100 EW	1000	975 - 1020	960 - 1005			
	1102 EW		995 - 1040	980 - 1025			
1120 EW	1200	1175 - 1220	1160 - 1205				

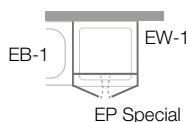
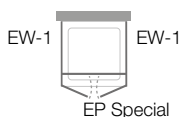

E-LITE EE

BOX AD ANGOLO PORTE BASCULANTI

ECKEINSTIEG PENDELTÜREN

CORNER ENTRY PIVOT DOORS

CABINA ANGULAR PUERTAS PIVOTANTES





Descrizione Articolo Artikelbezeichnung Model description Descripción artículo	Articolo Artikel Model Código	Misura piatto doccia Tassenmaß Tray size Medidas del plato mm	Estensibilità Verstellbarkeit Adjustability Extensibilidad mm	Misura centro vetro Mitte Glasmaß Glass size middle Medida vidrio centro mm	Misura Maß Size Medidas mm A	
<p>Box ad angolo porta basculante* EckEinstieg Pendeltür* Corner entry saloon door* Cabina angular puerta basculante*</p>	0070 EE - L/R	700	668 - 693	653 - 678	805	
	0075 EE - L/R	750	708 - 743	693 - 728	875	
	0080 EE - L/R	800	768 - 793	753 - 778	945	
	0082 EE - L/R		795 - 820	780 - 805	985	
	0090 EE - L/R	900	868 - 893	853 - 878	1085	
	0092 EE - L/R		895 - 920	880 - 905	1125	
	0100 EE - L/R	1000	968 - 993	953 - 978	1225	
	0102 EE - L/R		995 - 1020	980 - 1005	1265	

*Il lato di montaggio della cerniera da definire nell'ordine (sinistra L - destra R) / Montageseite des Scharniers bei Bestellung definieren (links L - rechts R)
Define the hinge assembly side when ordering (left L - right R) / Lado bisagra de la asamblea se indican en el pedido (izquierda L - derecha R)

Usate 2 articoli EE per il box completo / Verwenden Sie 2 x Artikel EE für die komplette Kabine / Use 2 article EE for the complete box / Le rogamos de usar 2 x EE para la cabina completa



E-LITE ET + EW

PORTA BASCULANTE CON LATERALE

PENDELTÜR MIT SEITENTEIL

PIVOT DOOR WITH SIDE PANEL

PUERTA BASCULANTE CON PARED LATERAL





High GLASS



ET 2000 EW 2000

GH High Glass GL 6mm

05 10

Descrizione Articolo Artikelbezeichnung Model description Descripción artículo	Articolo Artikel Model Código	Misura piatto doccia Tassenmaß Tray size Medidas del plato mm	Estensibilità Verstellbarkeit Adjustability Extensibilidad mm	Misura centro vetro Mitte Glasmaß Glass size middle Medida vidrio centro mm	Misura Maß Size Medidas mm		
					A	B	
 Porta basculante con sostegno* Pendeltür mit Stütze* Saloon door with support* Puerta basculante con soporte*	0070 ET - L/R	700	665 - 690	658 - 683	565	570	
	0075 ET - L/R	750	715 - 740	708 - 733	615	620	
	0080 ET - L/R	800	765 - 790	758 - 783	665	670	
	0082 ET - L/R		793 - 818	786 - 811	692	697	
	0090 ET - L/R	900	865 - 890	858 - 883	765	770	
	0092 ET - L/R		893 - 918	886 - 911	792	797	
	0100 ET - L/R	1000	965 - 990	958 - 983	865	870	
	0102 ET - L/R		993 - 1018	986 - 1011	892	897	

*Il lato di montaggio della cerniera da definire nell'ordine (sinistra L - destra R) / Montageseite des Scharniers bei Bestellung definieren (links L - rechts R)
 Define the hinge assembly side when ordering (left L - right R) / Lado bisagra de la asamblea se indican en el pedido (izquierda L - derecha R)

 Laterale per porta basculante Seitenteil für Pendeltür Side panel for saloon door Pared lateral para puerta basculante	0070 EW	700	665 - 710	650 - 695			
	0075 EW	750	715 - 760	700 - 745			
	0080 EW	800	765 - 810	750 - 795			
	0082 EW		800 - 845	785 - 830			
	0090 EW	900	865 - 910	850 - 895			
	0092 EW		900 - 945	885 - 930			
	0100 EW	1000	965 - 1010	950 - 995			
	0102 EW		1000 - 1045	985 - 1030			
	0120 EW	1200	1165 - 1210	1150 - 1195			



E-LITE EE-2

BOX AD ANGOLO PORTE BASCULANTI CON FISSO

ECKEINSTIEG PENDELTÜREN MIT FESTFELD

CORNER ENTRY PIVOT DOORS WITH FIX PANEL

CABINA ANGULAR PUERTAS PIVOTANTES CON FIJOS





Descrizione Articolo Artikelbezeichnung Model description Descripción artículo	Articolo Artikel Model Código	Misura piatto doccia Tassenmaß Tray size Medidas del plato mm	Estensibilità Verstellbarkeit Adjustability Extensibilidad mm MINMAX	Misura centro vetro Mitte Glasmaß Glass size middle Medida vidrio centro mm	Misura Maß Size Medidas mm		
					A	B	C
<p>Box ad angolo porta con fisso* Eckkabine Tür mit Festfeld* Corner entry door with fix panel* Cabina angular puerta con fijo*</p>	2070 EE - L/R	700	665 - 710	650 - 695	520	365	305
	2075 EE - L/R	750	715 - 760	700 - 745	590	415	305
	2080 EE - L/R	800	765 - 810	750 - 795	660	465	305
	2082 EE - L/R		793 - 838	778 - 823	700	492	305
	2090 EE - L/R	900	865 - 910	850 - 895	805	565	305
	2092 EE - L/R		893 - 938	878 - 923	840	592	305
	2100 EE - L/R	1000	965 - 1010	950 - 995	945	665	305
	2102 EE - L/R		993 - 1038	978 - 1023	985	692	305
	2110 EE - L/R	1100	1065 - 1110	1050 - 1095	945	665	405
	2120 EE - L/R	1200	1165 - 1210	1150 - 1195	945	665	505

*Il lato di montaggio della cerniera da definire nell'ordine (sinistra L - destra R) / Montageseite des Scharniers bei Bestellung definieren (links L - rechts R)
Define the hinge assembly side when ordering (left L - right R) / Lado bisagra de la asamblea se indican en el pedido (izquierda L - derecha R)

Usate 2 articoli EE per il box completo / Verwenden Sie 2 x Artikel EE für die komplette Kabine / Use 2 article EE for the complete box / Le rogamos de usar 2 x EE para la cabina completa

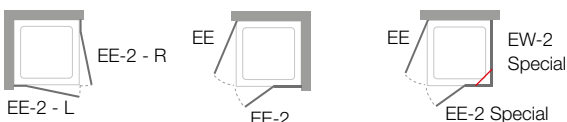

E-LITE ET-2 + EW

PORTA BASCULANTE CON FISSO E LATERALE

PENDELTÜR MIT FESTFELD UND SEITENTEIL

PIVOT DOOR WITH FIX AND SIDE PANEL

PUERTA BASCULANTE CON FIJO Y PARED LATERAL



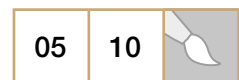

Descrizione Articolo Artikelbezeichnung Model description Descripción artículo	Articolo Artikel Model Código	Misura piatto doccia Tassenmaß Tray size Medidas del plato mm	Estensibilità Verstellbarkeit Adjustability Extensibilidad mm MINMAX	Misura centro vetro Mitte Glasmaß Glass size middle Medida vidrio centro mm	Misura Maß Size Medidas mm		
					A	B	C
<p>Porta basculante con fisso* Pendeltür mit Festfeld* Saloon door with fix panel* Puerta basculante con fijo*</p> <p>IN OUT</p>	2090 ET - L/R	900	863 - 908	855 - 900	565	305	570
	2092 ET - L/R		890 - 935	883 - 928	592	305	597
	2100 ET - L/R	1000	963 - 1008	955 - 1000	665	305	670
	2102 ET - L/R		990 - 1035	983 - 1028	692	305	697
	2110 ET - L/R	1100	1063 - 1108	1055 - 1100	665	405	670
	2120 ET - L/R	1200	1163 - 1208	1155 - 1200	665	505	670
	2140 ET - L/R	1400	1363 - 1408	1355 - 1400	665	705	670

*Il lato di montaggio della cerniera da definire nell'ordine (sinistra L - destra R) / Montageseite des Scharniers bei Bestellung definieren (links L - rechts R)
Define the hinge assembly side when ordering (left L - right R) / Lado bisagra de la asamblea se indican en el pedido (izquierda L - derecha R)

<p>Laterale* Seitenteil* Side panel* Pared lateral*</p>	0070 EW	700	665 - 710	650 - 695			
	0075 EW	750	715 - 760	700 - 745			
	0080 EW	800	765 - 810	750 - 795			
	0082 EW		800 - 845	785 - 830			
	0090 EW	900	865 - 910	850 - 895			
	0092 EW		900 - 945	885 - 930			
	0100 EW	1000	965 - 1010	950 - 995			
	0102 EW		1000 - 1045	985 - 1030			
	0120 EW	1200	1165 - 1210	1150 - 1195			



EW



ET-2 R



EW

EW-2 Special

ET-2 L

ET-2 Special

E-LITE EW-8

PARETE DOCCIA CON SOSTEGNO
RAUMABTRENNUNG MIT STÜTZE
SHOWER SCREEN WITH SUPPORT
SEPARA EL ESPACIO CON APOYO



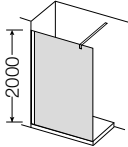

Descrizione Articolo Artikelbezeichnung Model description Descripción artículo		Articolo Artikel Model Código	Misura Maß Size Medidas mm A	Estensibilità Verstellbarkeit Adjustability Extensibilidad mm A	Estensibilità Verstellbarkeit Adjustability Extensibilidad mm B	Misura Maß Size Medidas mm A B
	Parete doccia con sostegno Raumabtrennung mit Stütze Shower screen with support Separa el espacio con apoyo	8100 EW	1000	985 - 1010	450 - 1200	
		8110 EW	1100	1085 - 1110	450 - 1200	
		8120 EW	1200	1185 - 1210	450 - 1200	
		8130 EW	1300	1285 - 1310	450 - 1200	
		8140 EW	1400	1385 - 1410	450 - 1200	
		8160 EW	1600	1585 - 1610	450 - 1200	



E-LITE EK-2

ANTINA PER VASCA CON FISSO

KLAPPWAND MIT FESTFELD

PIVOTING BATHTHSCREEN WITH FIX PANEL

HOJA PARA BAÑERA CON FIJO





High
GLASS



EK-2
1400



GH
High
Glass

GL

6 mm

05

10



Descrizione Articolo Artikelbezeichnung Model description Descripción artículo	Articolo Artikel Model Código	Estensibilità Verstellbarkeit Adjustability Extensibilidad mm	Misura Maß Size Medidas mm
			A B
<p>Antina per vasca con fisso* Klappwand mit Festfeld* Pivoting bathscreen with fix panel* Hoja para bañera con fijo*</p> <p>IN OUT</p>	2120 EK - L/R	1180 - 1205	470 720

*Il lato di montaggio da definire nell'ordine (sinistra L - destra R) / Montageseite bei Bestellung definieren (links L - rechts R)
Define the assembly side when ordering (left L - right R) / Lado de la asamblea se indican en el pedido (izquierda L - derecha R)

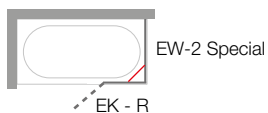

EW-2 Special

E-LITE FREE EN-1 + EB

PORTA SOFFIETTO + LATERALE PER VASCA
PENDEL-FALTTÜR + SEITENTEIL FÜR BADEWANNE
BI-FOLD DOOR + SIDE PANEL FOR BATHTUB
PUERTA PLEGABLE + LATERAL PARA BAÑERA





High GLASS



EN-1 2000	EB max 1800	
---------------------	-----------------------	--

GH High Glass	GL	6 mm
-------------------------	-----------	-----------------

05	10	
-----------	-----------	--

Descrizione Articolo Artikelbezeichnung Model description Descripción artículo	Articolo Artikel Model Código	Misura piatto doccia Tassenmaß Tray size Medidas del plato mm	Estensibilità Verstellbarkeit Adjustability Extensibilidad mm	Estensibilità laterale Verstellbarkeit Seitenteil Adjustability side panel Extensibilidad lateral mm	Misura Maß Size Medidas mm		
					A	B	C
 Porta soffietto* Pendel-Faltritt* Bi-fold door* Puerta plegable*	1070 EN - L/R	700	670 - 705		565	80	290
	1075 EN - L/R	750	720 - 755		615	80	315
	1080 EN - L/R	800	770 - 805		665	80	340
	1090 EN - L/R	900	870 - 905		765	80	390
	1100 EN - L/R	1000	970 - 1005		865	80	440
	1120 EN - L/R	1200	1170 - 1205		1065	80	540

*Il lato di montaggio della cerniera da definire nell'ordine (sinistra L - destra R) / Montageseite des Scharniers bei Bestellung definieren (links L - rechts R)
 Define the hinge assembly side when ordering (left L - right R) / Lado bisagra de la asamblea se indican en el pedido (izquierda L - derecha R)

 Laterale per vasca Seitenteil für Badewanne Side panel for bathtub Pared lateral para bañera	Articolo 0015 EB*	Misura 700 - 1000	Estensibilità 25	Misura		
				A	B	C

* Articolo é sempre un fuori misura / Artikel ist immer Sondermaß / article is always special measure / artículo es siempre medida especial

	Indicare sempre bordo piatto fino bordo vasca/muretto Oberkante Duschtasse bis Badewanne/Mauer immer angeben Indicate always shower tray to bathtub panel/wall Indique siempre borde superior plato de ducha y bañera/muro
--	--



E-LITE FREE EN-3

PORTA SOFFIETTO CON FISSO
PENDEL-FALTTÜR MIT FESTFELD
BI-FOLD DOOR WITH FIX PANEL
PUERTA PLEGABLE CON FIJO





High GLASS



EN-3
2000

GH High Glass GL 6mm

05 10

Descrizione Articolo Artikelbezeichnung Model description Descripción artículo	Articolo Artikel Model Código	Misura piatto doccia Tassenmaß Tray size Medidas del plato mm	Estensibilità Verstellbarkeit Adjustability Extensibilidad mm	Misura Maß Size Medidas mm A B
<p>Porta soffietto con fisso* Pendel-Falttür mit Festfeld* Bi-fold door with fix panel* Puerta plegable con fijo*</p> <p>IN OUT</p>	3711 EN - L/R	1170 - 1625	55	670/870 300-700

* Articolo é sempre un fuori misura / Artikel ist immer Sondermaß / article is always special measure / artículo es siempre medida especial

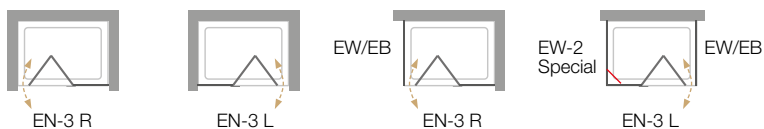

E-LITE FREE EE-1

BOX AD ANGOLO PIEGHEVOLE
ECKEINSTIEG KLAPPBAR
FOLDING CORNER ENTRY
CABINA ANGULAR PLEGABLE





High
GLASS



EE-1
2000

GH High Glass GL 6mm

05 10

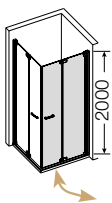
Descrizione Articolo Artikelbezeichnung Model description Descripción artículo	Articolo Artikel Model Código	Misura piatto doccia Tassenmaß Tray size Medidas del plato mm	Estensibilità Verstellbarkeit Adjustability Extensibilidad mm	Misura centro vetro Mitte Glasmaß Glass size middle Medida vidrio centro mm	Misura Maß Size Medidas mm		
					A	B	C
 <p>Box ad angolo pieghevole* EckEinstieg klappbar* Folding corner entry* Cabina angular plegable*</p>	1070 EE - L/R	700	668 - 693	653 - 678	805	80	290
	1075 EE - L/R	750	718 - 743	703 - 728	875	80	315
	1080 EE - L/R	800	768 - 793	753 - 778	945	80	340
	1082 EE - L/R		803 - 828	788 - 813	995	80	375
	1090 EE - L/R	900	868 - 893	853 - 878	1085	80	390
	1092 EE - L/R		903 - 928	888 - 913	1135	80	425
	1100 EE - L/R	1000	968 - 993	953 - 978	1225	80	440
	1102 EE - L/R		1003 - 1028	988 - 1013	1275	80	475
	1120 EE - L/R	1200	1168 - 1193	1153 - 1178	1370	80	540

*Il lato di montaggio della cerniera da definire nell'ordine (sinistra L - destra R) / Montageseite des Scharniers bei Bestellung definieren (links L - rechts R)
Define the hinge assembly side when ordering (left L - right R) / Lado bisagra de la asamblea se indican en el pedido (izquierda L - derecha R)

Usate 2 articoli per il box completo/Verwenden Sie 2 x Artikel für die komplette Kabine/Use 2 articles for the complete enclosure/Le rogamos de usar 2 x artículos para la cabina completa

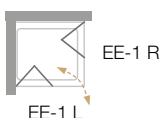

E-LITE FREE EE-3

BOX ANGOLO PIEGHEVOLE CON FISSO
ECKEINSTIEG KLAPPBAR MIT FESTFELD
FOLDING CORNER ENTRY WITH FIX PANEL
CABINA ANGULAR PLEGABLE CON FIJO



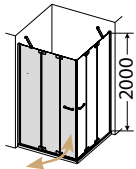

Descrizione Articolo Artikelbezeichnung Model description Descripción artículo	Articolo Artikel Model Código	Misura piatto doccia Tassenmaß Tray size Medidas del plato mm	Estensibilità Verstellbarkeit Adjustability Extensibilidad mm	Misura Maß Size Medidas mm A B
 <p>Box angolo pieghevole con fisso* EckEinstieg klappbar mit Festfeld* Folding corner entry with fix panel* Cabina angular plegable con fijo*</p> <p>IN OUT</p>	3511 EE - L/R	965 - 1610	45	805-1225 300-700

* Articolo é sempre un fuori misura / Artikel ist immer Sondermaß / article is always special measure / artículo es siempre medida especial

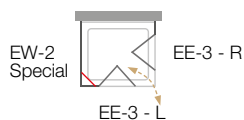
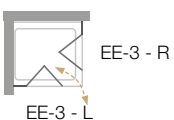

E-LITE FREE ET-1 + EW

PORTA SOFFIETTO + LATERALE
PENDEL-FALTTÜR + SEITENTEIL
BI-FOLD DOOR + SIDE PANEL
PUERTA PLEGABLE + LATERAL





High
GLASS



ET-1 2000 EW 2000

GH High Glass GL 6mm

05 10

Descrizione Articolo Artikelbezeichnung Model description Descripción artículo	Articolo Artikel Model Código	Misura piatto doccia Tassenmaß Tray size Medidas del plato mm	Estensibilità Verstellbarkeit Adjustability Extensibilidad mm	Misura centro vetro Mitte Glasmaß Glass size middle Medida vidrio centro mm	Misura Maß Size Medidas mm		
					A	B	C
<p>Porta soffietto * Pendel-Faltrittür * Bi-fold door * Puerta plegable *</p> <p>IN OUT</p>	1070 ET - L/R	700	665 - 690	658 - 683	565	80	290
	1075 ET - L/R	750	715 - 740	708 - 733	615	80	315
	1080 ET - L/R	800	765 - 790	758 - 783	665	80	340
	1082 ET - L/R		800 - 825	793 - 818	700	80	375
	1090 ET - L/R	900	865 - 890	858 - 883	765	80	390
	1092 ET - L/R		900 - 925	893 - 918	800	80	425
	1100 ET - L/R	1000	965 - 990	958 - 983	865	80	440
	1102 ET - L/R		1000 - 1025	993 - 1018	900	80	475
	1120 ET - L/R	1200	1165 - 1190	1158 - 1183	1065	80	540

*Il lato di montaggio della cerniera da definire nell'ordine (sinistra L - destra R) / Montageseite des Scharniers bei Bestellung definieren (links L - rechts R)
Define the hinge assembly side when ordering (left L - right R) / Lado bisagra de la asamblea se indican en el pedido (izquierda L - derecha R)

<p>Laterale con sostegno Seitenteil mit Stütze Side panel with support Pared lateral con soporte</p> <p>MINMAX</p>	0070 EW	700	665 - 710	650 - 695			
	0075 EW	750	715 - 760	700 - 745			
	0080 EW	800	765 - 810	750 - 795			
	0082 EW		800 - 845	785 - 830			
	0090 EW	900	865 - 910	850 - 895			
	0092 EW		900 - 945	885 - 930			
	0100 EW	1000	965 - 1010	950 - 995			
	0102 EW		1000 - 1045	985 - 1030			
	0120 EW	1200	1165 - 1210	1150 - 1195			

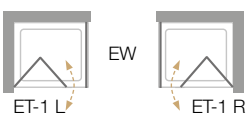

E-LITE FREE EK-1

ANTINA PER VASCA A 2 ANTE PIEGHEVOLE

2-TEILIGE KLAPPWAND

DOUBLE PIVOTING BATHTHSCREEN

HOJA PARA BAÑERA 2 ELEMENTOS





High
GLASS



EK-1
1400

GH High Glass GL 6mm

05 10

Descrizione Articolo Artikelbezeichnung Model description Descripción artículo	Articolo Artikel Model Código	Misura vasca Wannenmaß Bathtub size Medidas de la bañera mm C	Estensibilità Verstellbarkeit Adjustability Extensibilidad mm	Misura Maß Size Medidas mm	
				A	B
 <p>IN OUT</p> <p>Antina per vasca a 2 ante pieghevole* 2-teilige Klappwand* Double pivoting bathscreen* Hoja para bañera 2 elementos*</p>	1120 EK - L/R	650 min.	1200 - 1225	650	560

*Il lato di montaggio da definire nell'ordine (sinistra L - destra R) / Montageseite bei Bestellung definieren (links L - rechts R)
Define the assembly side when ordering (left L - right R) / Lado de la asamblea se indican en el pedido (izquierda L - derecha R)

