

S-LITE



ULTIMATE SLIDING CONCEPT
WITH MINIMALIST
EXCELLENT LOOK



PROVEX
comfort in the bathroom

INDICE S-LITE
 INHALT S-LITE
 INDEX S-LITE
 INDICE S-LITE

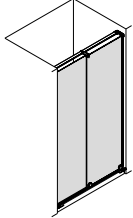
SN

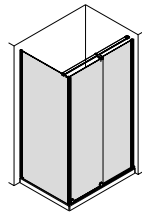

SN-1 + SW



SI

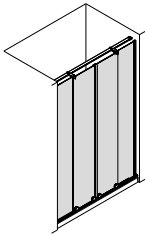

SC

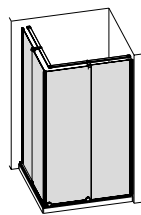

SR

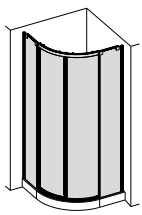

SW-6

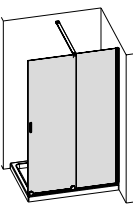

SW-7

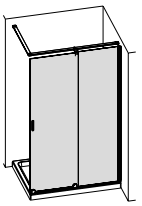

SN/SI/SC

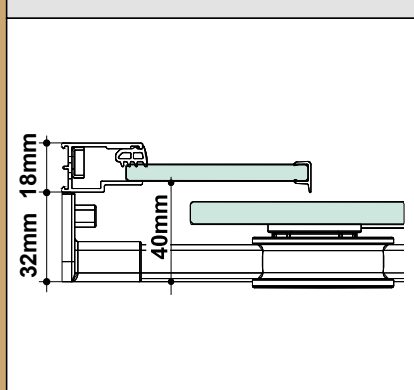

SN

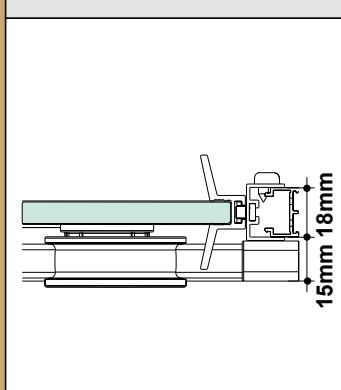

SW

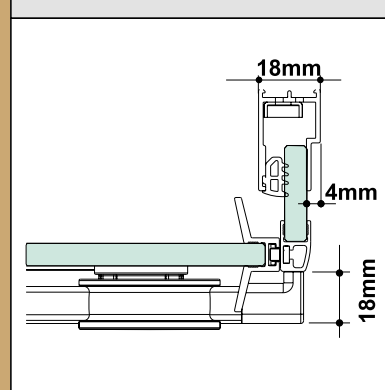



BOX DOCCIA CON PORTE SCORREVOLI

- Design Studio Talocci + Pallocca
- Altezza 2000 mm ed estensibilità da 25 a 50 mm
- Spessore vetro 8 mm per le porte scorrevoli e laterali
- Maniglia a tutta altezza per un design unico
- Posizione delle ruote in basso garantisce un'ottimo scorrimento
- Ruote a cuscinetto in acciaio inox regolabili in altezza
- Massima stabilità grazie al sostegno continuo e montaggio semplice con dima
- Viti planari all'interno del box facilitano la pulizia
- Profilo a parete senza bisogno di silicone



DUSCHKABINEN MIT SCHIEBETÜREN

- Design Studio Talocci + Pallocca
- Höhe 2000 mm und Verstellbereich von 25 - 50 mm
- Glasstärke 8 mm für die Schiebetüren und Seitenteile
- Durchgehende Griffleiste für ein einzigartiges Design
- Positionierung der Räder unten garantiert optimale Gleiteigenschaft
- Kugelgelagerte Räder aus Edelstahl mit Höhenverstellung
- Höchste Stabilität durch durchgehende Stütze und einfachste Montage mit Schablone
- Ideale Reinigung durch versenkte Schrauben im Glas
- Silikonfreier Wandanschluss



SHOWER ENCLOSURE WITH SLIDING DOORS

- Design Studio Talocci + Pallocca
- Height 2000 mm and adjustment from 25 - 50 mm
- 8 mm glass sliding door and side panels
- Full-length handle strip for a unique design
- Bottom wheels ensure smooth silent door motion
- Ball bearing stainless steel wheels adjustable in height
- High stability through continuous support and easy assembly
- Screws are sunk into the glass and facilitate the cleaning
- Silicone-free wall junction

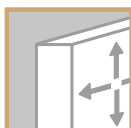

MAMPARAS DE DUCHA CON PUERTAS CORREDIZAS

- Design Studio Talocci + Pallocca
- Altura 2000 mm y extensibilidad de 25 - 50 mm
- Vidrio de 8 mm de espesor para puertas corredizas y pared laterales
- Tirador de longitud completa para un diseño único
- La posición de las ruedas por debajo, garantiza un deslizamiento optimal
- Ruedas de acero inoxidable con cojinetes regulables en altura
- Máxima estabilidad gracias al apoyo continuo y montaje simple
- Tornillos planos en el interior de la cabina facilitando la limpieza
- Fijación a pared sin necesidad de silicona

S-LITE SN

PORTA SCORREVOLE CON FISSO
SCHIEBETÜR MIT FESTFELD
SLIDING DOOR WITH FIX ELEMENT
PUERTA CORREDERA CON FIJO



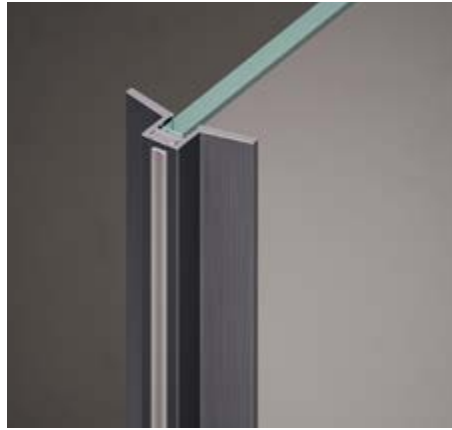

High
GLASS



SN
2000



GH
High
Glass

GL

8/6 mm

| SPECIAL | | | | 10 | 05 |  |
|---------|----|----|----|----|----|---|
| 01 | 06 | 09 | 70 | | | |

| Descrizione Articolo Artikelbezeichnung Model description Descripción artículo | Articolo Artikel Article Código | Misura piatto doccia Tassenmaß Tray size Medidas del plato mm | Estensibilità Verstellbarkeit Adjustability Extensibilidad mm | Misura Maß Size Medidas mm | |  |
|--|--|---|---|--|-----|---|
| | | | | A** | B | |
|  <p>Porta scorrevole con fisso* Schiebetür mit Festfeld* Sliding door with fix element* Puerta corredera con fijo*</p> | 0100 SN - L/R | 1000 | 965 - 1000 | 447 | 534 | |
| | 0120 SN - L/R | 1200 | 1165 - 1200 | 547 | 634 | |
| | 0140 SN - L/R | 1400 | 1365 - 1400 | 647 | 734 | |
| | 0121 SN - L/R | SPECIAL | 950 - 1209 | | | |
| | 0141 SN - L/R | SPECIAL | 1210 - 1410 | | | |

*Lato fisso della porta da definire nell'ordine (sinistra L - destra R) / Montageseite des fixen Elements bei Bestellung definieren (links L - rechts R)
Define the fix side when ordering (left L - right R) / Lado fijo se indican en el pedido (izquierda L - derecha R)

**Attenzione alla misura A (entrata) / Achtung auf das Maß A (Einstieg) / Attention to the size A (entrance) / Atención en la medida A (entrada)

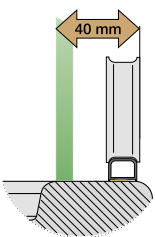

0015 SB
Special



SN - L

SN - R

SN - L

SN - R

S-LITE SN-1 + SW

PORTA SCORREVOLE CON LATERALE

SCHIEBETÜR MIT SEITENTEIL

SLIDING DOOR WITH SIDE PANEL

PUERTA CORREDERA CON PARED LATERAL





High
GLASS



SW **SN-1**
2000 2000



GH **GL** 8/6 mm
High Glass

| SPECIAL | | | | 10 | 05 | |
|---------|----|----|----|----|----|--|
| 01 | 06 | 09 | 70 | | | |

| Descrizione Articolo Artikelbezeichnung Model description Descripción artículo | Articolo Artikel Article Código | Misura piatto doccia Tassenmaß Tray size Medidas del plato mm | Estensibilità Verstellbarkeit Adjustability Extensibilidad mm | Misura Maß Size Medidas mm | | |
|--|--|---|---|--|-----|--|
| | | | | A** | B | |
| Porta scorrevole con fisso* Schiebetür mit Festfeld* Sliding door with fix element* Puerta corredera con fijo* | 1100 SN - L/R | 1000 | 970 - 995 | 447 | 534 | |
| | 1120 SN - L/R | 1200 | 1170 - 1195 | 547 | 634 | |
| | 1140 SN - L/R | 1400 | 1370 - 1395 | 647 | 734 | |
| | 1121 SN - L/R | SPECIAL | 950 - 1209 | | | |
| | 1141 SN - L/R | SPECIAL | 1210 - 1410 | | | |
| | | | | | | |

*Lato fisso della porta da definire nell'ordine (sinistra L - destra R) / Montageseite des fixen Elements bei Bestellung definieren (links L - rechts R)
 Define the fix side when ordering (left L - right R) / Lado fijo se indican en el pedido (izquierda L - derecha R)

| Laterale per porta scorrevole Seitenteil für Schiebetür Side panel for sliding door Pared lateral para puerta corredera | Articolo | Misura | Estensibilità | 8 mm | | | | |
|---|----------|---------|---------------|------|--|--|--|--|
| | 0070 SW | 700 | 670 - 695 | | | | | |
| | 0075 SW | 750 | 720 - 745 | | | | | |
| | 0080 SW | 800 | 770 - 795 | | | | | |
| | 0090 SW | 900 | 870 - 895 | | | | | |
| | 0100 SW | 1000 | 970 - 995 | | | | | |
| | 0091 SW | SPECIAL | 600 - 909 | | | | | |
| | 0121 SW | SPECIAL | 910 - 1210 | | | | | |

**Attenzione alla misura A (entrata) / Achtung auf das Maß A (Einstieg) / Attention to the size A (entrance) / Atención en la medida A (entrada)

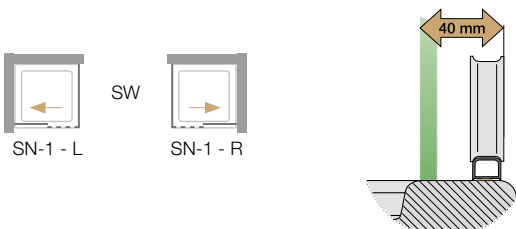

S-LITE SI

PORTE SCORREVOLI IN LINEA

SCHIEBETÜREN IN LINIE

SLIDING DOORS IN LINE

PUERTAS CORREDERAS IN LINEA





High
GLASS



SI
2000



GH
High
Glass

GL

8/6 mm

| SPECIAL | | | | 10 | 05 | |
|---------|----|----|----|----|----|--|
| 01 | 06 | 09 | 70 | | | |

| Descrizione Articolo Artikelbezeichnung Model description Descripción artículo | Articolo Artikel Article Código | Misura piatto doccia Tassenmaß Tray size Medidas del plato mm | Estensibilità Verstellbarkeit Adjustability Extensibilidad mm | Misura Maß Size Medidas mm | | |
|--|--|---|---|--|-----|--|
| | | | | A | B | |
| <p>Porte scorrevoli in linea - porte Schiebetüren in Linie - Türen Sliding doors in line - doors Puertas correderas in linea - puertas</p> | 0140 SI-T | 1400 | 1360 - 1410 | 8 mm | 609 | |
| | 0150 SI-T | 1500 | 1460 - 1510 | | 659 | |
| | 0160 SI-T | 1600 | 1560 - 1610 | | 709 | |
| | 0170 SI-T | 1700 | 1660 - 1710 | | 759 | |
| | 0180 SI-T | 1800 | 1760 - 1810 | | 809 | |
| <p>Porte in linea con sostegno - fissi in linea Schiebetüren mit Stütze - Festfelder Sliding doors with support - fix panels Puertas correderas con apoyo - elementos fijos</p> | 0140 SI-S | 1400 | 1360 - 1410 | 6 mm | 400 | |
| | 0150 SI-S | 1500 | 1460 - 1510 | | 450 | |
| | 0160 SI-S | 1600 | 1560 - 1610 | | 500 | |
| | 0170 SI-S | 1700 | 1660 - 1710 | | 550 | |
| | 0180 SI-S | 1800 | 1760 - 1810 | | 600 | |

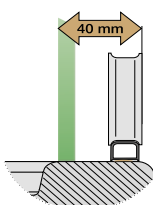
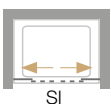

S-LITE SC

BOX AD ANGOLO SCORREVOLE

ECKKABINE MIT SCHIEBETÜREN

CORNER ENTRY WITH SLIDING DOORS

CABINA ANGULAR CON PUERTAS CORREDERAS



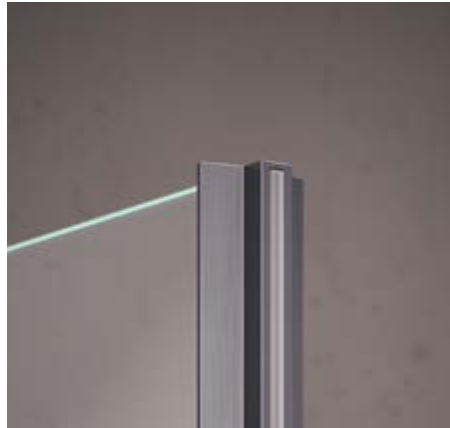

High
GLASS



SC
2000



GH
High
Glass

GL

8/6 mm

| SPECIAL | | | | 10 | 05 | |
|---------|----|----|----|----|----|--|
| 01 | 06 | 09 | 70 | | | |

| Descrizione Articolo Artikelbezeichnung Model description Descripción artículo | Articolo Artikel Article Código | Misura piatto doccia Tassenmaß Tray size Medidas del plato mm | Estensibilità Verstellbarkeit Adjustability Extensibilidad mm | Misura Maß Size Medidas mm A** | B | |
|---|--|---|---|---|-----|--|
| <p>Box ad angolo scorrevole* Eckkabine mit Schiebetüren* Corner entry with sliding doors* Cabina angular con puertas correderas*</p> | 0075 SC - L/R | 750 | 715 - 740 | 435 | 403 | |
| | 0080 SC - L/R | 800 | 765 - 790 | 470 | 428 | |
| | 0090 SC - L/R | 900 | 865 - 890 | 541 | 478 | |
| | 0100 SC - L/R | 1000 | 965 - 990 | 612 | 528 | |
| | 0120 SC - L/R | 1200 | 1165 - 1190 | 753 | 628 | |
| | 0091 SC - L/R | SPECIAL | 665 - 909 | | | |
| | 0121 SC - L/R | SPECIAL | 910 - 1210 | | | |

*Usate 1 articolo cad. di SC-L e SC-R / Verwenden Sie je 1 x Artikel SC-L und SC-R / Use 1 article each SC-L and SC-R / Le rogamos de usar 1 cad. SC-L y SC-R

**Attenzione alla misura A (entrata) / Achtung auf das Maß A (Einstieg) / Attention to the size A (entrance) / Atención en la medida A (entrada)

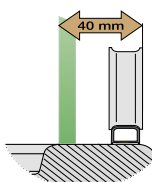
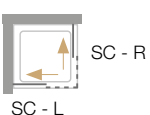
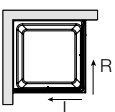

S-LITE SR

BOX ROTONDO SCORREVOLE

RUNDKABINE MIT SCHIEBETÜREN

SHOWER CUBICLE WITH SLIDING DOORS

CABINA SEMICIRCULAR CON PUERTAS CORREDERAS





High
GLASS



SR
2000



GH
High
Glass

GL

6 mm

10 05



| Descrizione Articolo Artikelbezeichnung Model description Descripción artículo | Articolo Artikel Article Código | Misura piatto doccia Tassenmaß Tray size Medidas del plato mm L R | Estensibilità Verstellbarkeit Adjustability Extensibilidad mm | Misura piatto installato Tasseneinbaumaß Tray installation measure Medidas del plato instalado mm | Misura Maß Size Medidas mm A | |
|---|--|--|---|---|---|--|
| <p>Box rotondo scorrevole Rundkabine mit Schiebetüren Shower cubicle with sliding doors Cabina semicircular con puertas correderas</p> | 6080 SR | 800 x 800 R 550 | 770 - 795 | 780 - 805 | 403 | |
| | 6090 SR | 900 x 900 R 550 | 870 - 895 | 880 - 905 | 554 | |
| | 6100 SR | 1000 x 1000 R 550 | 970 - 995 | 980 - 1005 | 554 | |
| | 4080 SR | 800 x 800 R 500 | 770 - 795 | 780 - 805 | 411 | |
| | 4090 SR | 900 x 900 R 500 | 870 - 895 | 880 - 905 | 484 | |
| | 4100 SR | 1000 x 1000 R 500 | 970 - 995 | 980 - 1005 | 484 | |

R = Raggio/Radius/radius/radio

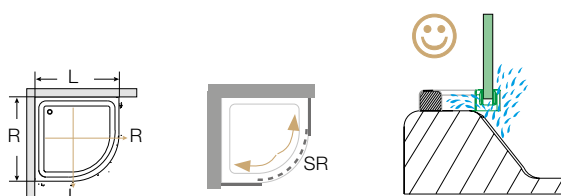

S-LITE SW-6

ANTA SCORREVOLE CON FISSO

2-TEILIGE SCHIEBETÜR MIT FESTFELD

DOUBLE SLIDING DOOR WITH FIX PANEL

PUERTA CORREDERA CON FIJO



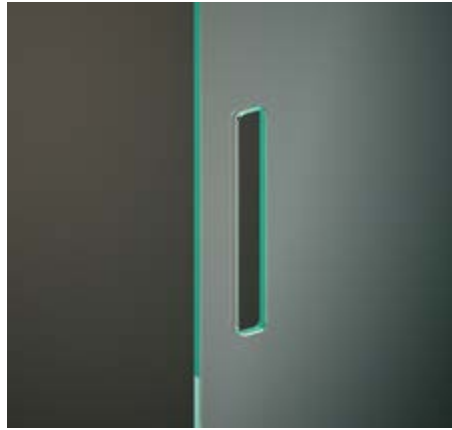

High
GLASS



SW-6
2000



GH
High
Glass

GL

8/6 mm

| SPECIAL | | | | 10 | 05 | |
|---------|----|----|----|----|----|--|
| 01 | 06 | 09 | 70 | | | |

| Descrizione Articolo Artikelbezeichnung Model description Descripción artículo | Articolo Artikel Article Código | Estensibilità Verstellbarkeit Adjustability Extensibilidad mm | Misura Maß Size Medidas mm | | | |
|---|--|---|--|-----|-----|---|
| | | | | A | B | C |
| <p>Anta scorrevole con fisso 2-teilige Schiebetür mit Festfeld Double sliding door with fix panel Puerta correderas con fijo</p> | 6100 SW - L/R* | 985 - 1010 | 500 - 1240 | 559 | 461 | |
| | 6120 SW - L/R* | 1185 - 1210 | 500 - 1240 | 659 | 561 | |
| | 6140 SW - L/R* | 1385 - 1410 | 500 - 1240 | 759 | 661 | |
| | 6121 SW - L/R* | 800 - 1209 | 500 - 1240 | | | |
| | 6141 SW - L/R* | 1210 - 1410 | 500 - 1240 | | | |

*Lato fisso della porta da definire nell'ordine (sinistra L - destra R) / Montageseite des fixen Elements bei Bestellung definieren (links L - rechts R)
Define the fix side when ordering (left L - right R) / Lado fijo se indican en el pedido (izquierda L - derecha R)

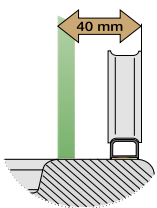

SW-6 - L



SW-6 - R

S-LITE SW-7

ANTA SCORREVOLE CON FISSO

2-TEILIGE SCHIEBETÜR MIT FESTFELD

DOUBLE SLIDING DOOR WITH FIX PANEL

PUERTA CORREDERA CON FIJO





| | | | | | | |
|---------|----|----|----|----|----|--|
| SPECIAL | | | | 10 | 05 | |
| 01 | 06 | 09 | 70 | | | |

| Descrizione Articolo Artikelbezeichnung Model description Descripción artículo | Articolo Artikel Article Código | Estensibilità Verstellbarkeit Adjustability Extensibilidad mm | Misura Maß Size Medidas mm | | | |
|---|--|---|--|-----|-----|---|
| | | | | A | B | C |
| <p>Anta scorrevole con fisso 2-teilige Schiebetür mit Festfeld Double sliding door with fix panel Puerta correderas con fijo</p> | 7100 SW - L/R* | 985 - 1010 | 500 - 1240 | 559 | 461 | |
| | 7120 SW - L/R* | 1185 - 1210 | 500 - 1240 | 659 | 561 | |
| | 7140 SW - L/R* | 1385 - 1410 | 500 - 1240 | 759 | 661 | |
| | 7121 SW - L/R* | 800 - 1209 | 500 - 1240 | | | |
| | 7141 SW - L/R* | 1210 - 1410 | 500 - 1240 | | | |

*Lato fisso della porta da definire nell'ordine (sinistra L - destra R) / Montageseite des fixen Elements bei Bestellung definieren (links L - rechts R)
Define the fix side when ordering (left L - right R) / Lado fijo se indican en el pedido (izquierda L - derecha R)

