

TOGA



MODERN DESIGN AND
SOPHISTICATED SOLUTIONS

PROVEX
comfort in the bathroom

INDICE TOGA
 INHALT TOGA
 INDEX TOGA
 INDICE TOGA

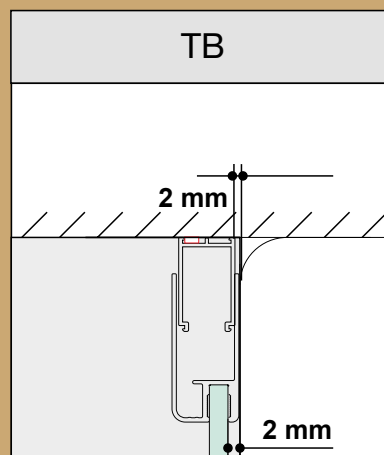
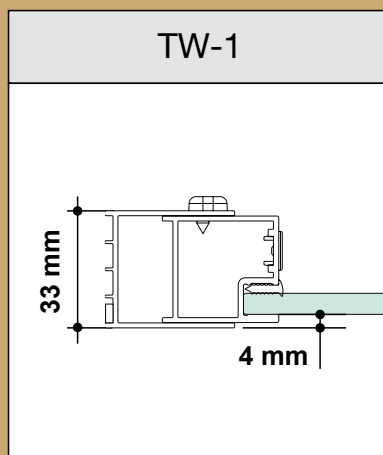
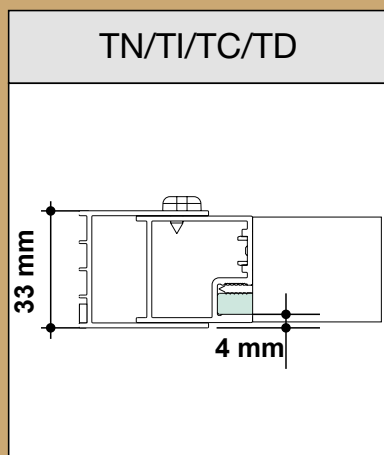
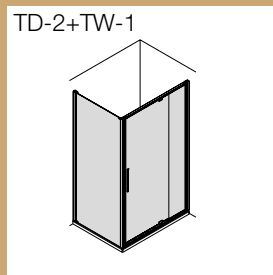
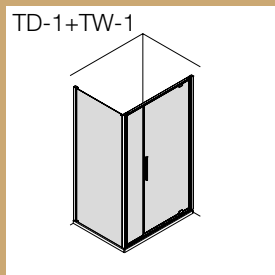
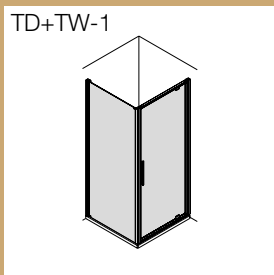
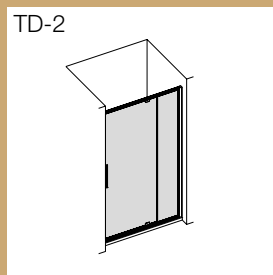
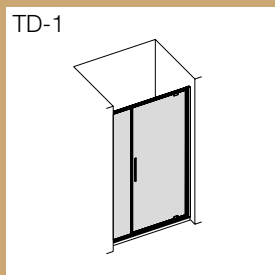
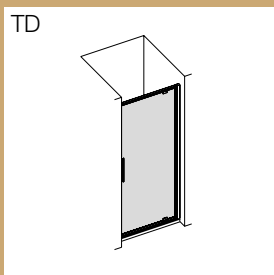
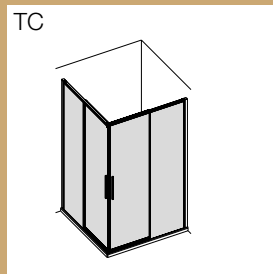
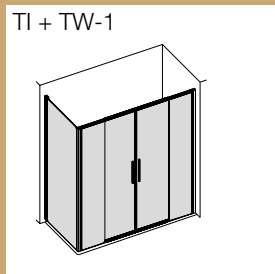
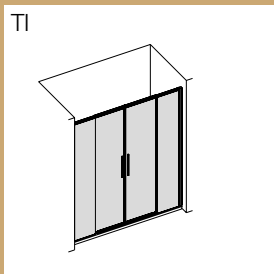
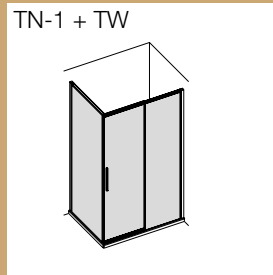
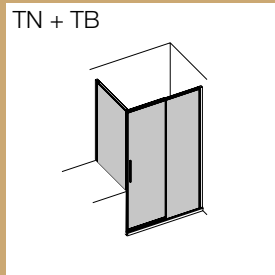
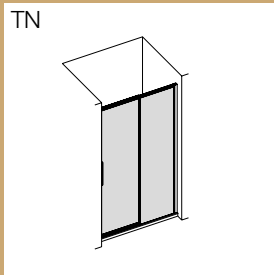

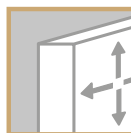

BOX CON PARZIALE TELAIO

- Design Provex con forma moderna e minimalista
- Altezza 2000 mm, spessore vetro 6 mm ed estensibilità da 25 – 50 mm
- Ruote di scorrimento con regolazione eccentrica
- Porte scorrevoli sganciabili per una pulizia più facile
- Reversibilità rende il box versatile
- I box doccia possono essere montati con o senza profilo a terra
- Tenuta stagna testata a 11 litri/minuto
- Profilo a parete senza bisogno di silicone

TEILRAHMENKABINEN

- Design Provex mit moderner und puristischer Formgebung
- Höhe 2000 mm, 6 mm Glas und Verstellbereich von 25-50 mm
- Laufräder mit exzentrischer Höhenverstellung
- Ideale Reinigung mit Aushängemechanismus der Tür
- Reversibilität gewährleistet einfache Abwicklung
- Kabine kann mit oder ohne Bodenleiste montiert werden
- Getestete Wasserdichtigkeit von 11 Liter/Minute
- Silikonfreier Wandanschluss

PARTIAL FRAMED SHOWER ENCLOSURE

- Studio Provex, modern and minimalistic design
- Height 2000 mm, glass 6 mm and adjustment 25-50 mm
- Precision bearing wheels featuring eccentric height adjustment
- Base of sliding doors releasable for easy cleaning
- Fully reversible for ease of ordering and installation
- The enclosure can be installed with or without bottom profile
- Tested to be watertight 11 litres per minute
- Silicone free wall junction

CABINA CON PERFIL PARCIAL

- Diseño Provex con una forma moderna y minimalista
- Altura 2000 mm, vidrio 6 mm y extensibilidad de 25 – 50 mm
- Rodamientos para el deslizamiento con ajuste excéntrico
- Puerta deslizante desmontable para una limpieza fácil
- Reversible, para más versatilidad
- Todas las cabinas se puede montar con o sin perfil a suelo
- Estanqueidad comprobada para caudal de 11 litros/minutos
- Fijación a pared sin necesidad de silicona

TOGA TN

PORTA SCORREVOLE
SCHIEBETÜR
SLIDING DOOR
PUERTA CORREDERA





SPECIAL				10	05	
01	06	09	70			

Descrizione Articolo Artikelbezeichnung Model description Descripción artículo	Articolo Artikel Model Código	Misura piatto doccia Tassenmaß Tray size Medidas del plato mm	Estensibilità Verstellbarkeit Adjustability Extensibilidad mm	Misura Maß Size Medidas mm		
				A	B	
<p>Porta scorrevole Schiebetür Sliding door Puerta corredera</p>	0100 TN	1000	968 - 1018	385	555	
	0120 TN	1200	1168 - 1218	485	655	
	0140 TN	1400	1368 - 1418	585	755	
	0907 TN	SPECIAL	968 - 1218			
	0909 TN	SPECIAL	1219 - 1418			

<p>Porta scorrevole - fisso in linea Schiebetür - Festfeld Sliding door - fix element Puerta corredera - elemento fijo</p>	0911 TN - S	SPECIAL	1419 - 1620			

<p>Porta scorrevole - porta Schiebetür - Tür Sliding door - door Puerta corredera - puerta</p>	0911 TN - T	SPECIAL	1419 - 1620	585		

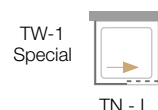

TOGA TN-1 + TW

PORTA SCORREVOLE
SCHIEBETÜR
SLIDING DOOR
PUERTA CORREDERA





SPECIAL				10	05	
01	06	09	70			

Descrizione Articolo Artikelbezeichnung Model description Descripción artículo	Articolo Artikel Model Código	Misura piatto doccia Tassenmaß Tray size Medidas del plato mm	Estensibilità Verstellbarkeit Adjustability Extensibilidad mm	Misura centro vetro Mitte Glasmaß Glass size middle Medida vidrio centro mm	Misura Maß Size Medidas mm		
					A	B	
<p>Porta scorrevole Schiebetür Sliding door Puerta corredera</p>	1100 TN	1000	965 - 990	958 - 983	410	555	
	1120 TN	1200	1165 - 1190	1158 - 1183	510	655	
	1140 TN	1400	1365 - 1390	1358 - 1383	610	755	
	1907 TN	SPECIAL	965 - 1190				
	1909 TN	SPECIAL	1191 - 1410				
<p>Porta scorrevole - fisso in linea Schiebetür - Festfeld Sliding door - fix element Puerta corredera - elemento fijo</p>	1911 TN - S	SPECIAL	1411 - 1610				
<p>Porta scorrevole - porta Schiebetür - Tür Sliding door - door Puerta corredera - puerta</p>	1911 TN - T	SPECIAL	1411 - 1610				
<p>Laterale per porta scorrevole Seitenteil für Schiebetür Side panel for sliding door Pared lateral para puerta corredera</p>	0070 TW	700	665 - 690	658 - 683			
	0075 TW	750	715 - 740	708 - 733			
	0080 TW	800	765 - 790	758 - 783			
	0090 TW	900	865 - 890	858 - 883			
	0100 TW	1000	965 - 990	958 - 983			
	0904 TW	SPECIAL	600 - 909				
	0907 TW	SPECIAL	910 - 1210				



TOGA TI

PORTE SCORREVOLI IN LINEA

SCHIEBETÜREN IN LINIE

SLIDING DOORS IN LINE

PUERTAS CORREDERAS IN LINEA

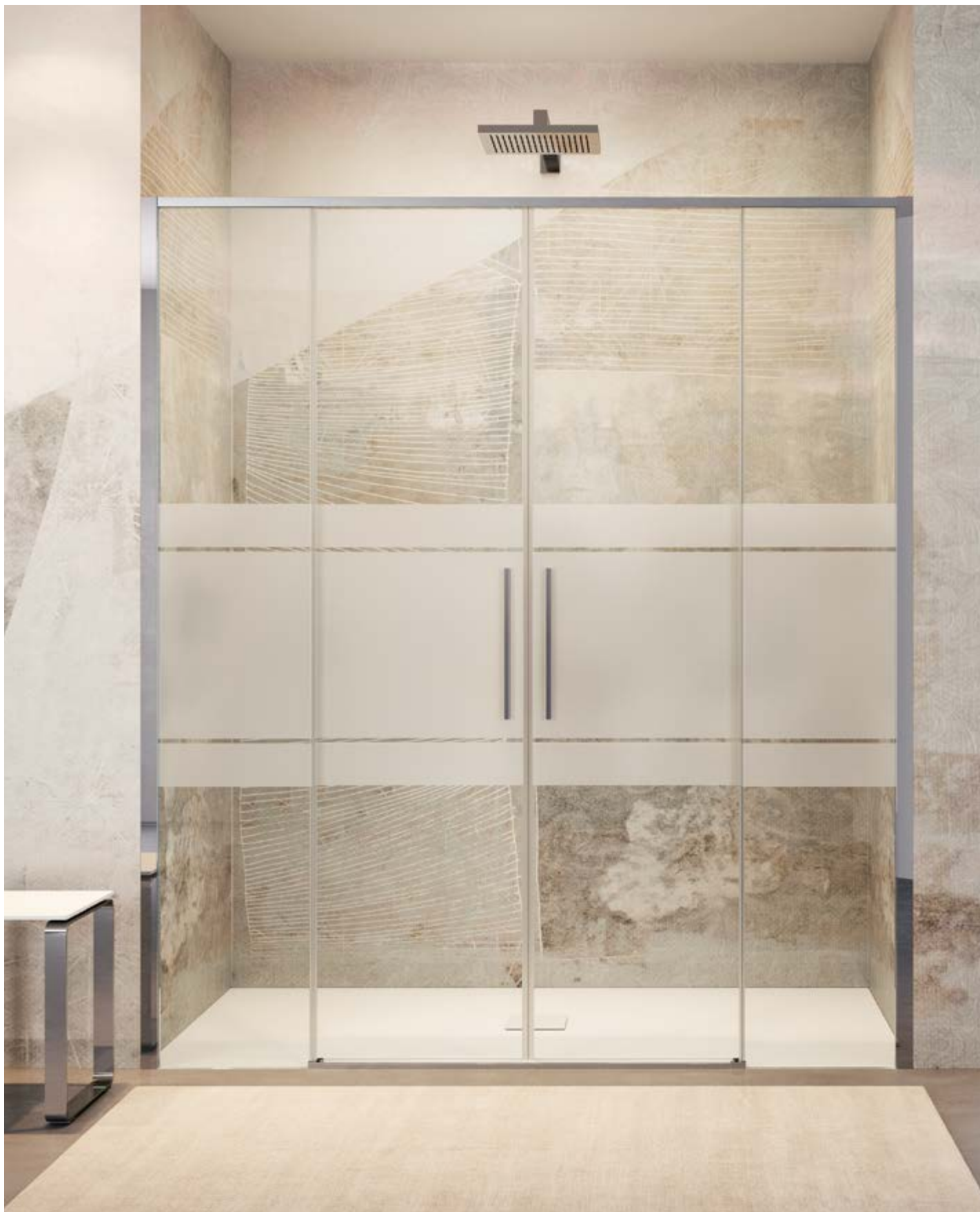



SPECIAL				10	05	
01	06	09	70			

Descrizione Articolo Artikelbezeichnung Model description Descripción artículo	Articolo Artikel Model Código	Misura piatto doccia Tassenmaß Tray size Medidas del plato mm	Estensibilità Verstellbarkeit Adjustability Extensibilidad mm	Misura Maß Size Medidas mm		
<p>Porte scorrevoli in linea - porte Schiebetüren in Linie - Türen Sliding doors in line - doors Puertas correderas in línea - puertas</p>	0140 TI-T	1400	1365 - 1415	490		
	0160 TI-T	1600	1565 - 1615	590		
	0180 TI-T	1800	1765 - 1815	690		
<p>Porte in linea in linea- fissi in linea Schiebetüren in Linie - Festfelder Sliding doors in line - fix elements Puertas correderas in línea - elementos fijos</p>	0140 TI-S	1400	1365 - 1415		305	
	0160 TI-S	1600	1565 - 1615		355	
	0180 TI-S	1800	1765 - 1815		405	

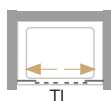

TOGA TI + TW-1

PORTE SCORREVOLI IN LINEA CON LATERALE

SCHIEBETÜREN IN LINIE MIT SEITENTEIL

SLIDING DOORS IN LINE WITH SIDE PANEL

PUERTAS CORREDERAS IN LINEA CON PARED LATERAL



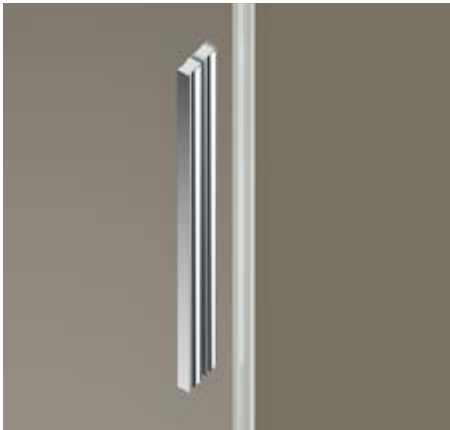

TI 2000	TW-1 2000	
------------	--------------	--

GH High Glass	GL	6 mm
------------------	----	------

SPECIAL				10	05	
01	06	09	70			

Descrizione Articolo Artikelbezeichnung Model description Descripción artículo	Articolo Artikel Model Código	Misura piatto doccia Tassenmaß Tray size Medidas del plato mm	Estensibilità Verstellbarkeit Adjustability Extensibilidad mm	Misura centro vetro Mitte Glasmaß Glass size middle Medida vidrio centro mm	Misura Maß Size Medidas mm A	B	
<p>Porte scorrevoli in linea - porte Schiebetüren in Linie - Türen Sliding doors in line - doors Puertas correderas in línea - puertas</p>	0140 TI-T	1400	1380 - 1430	1373 - 1423	490		
	0160 TI-T	1600	1580 - 1630	1573 - 1623	590		
	0180 TI-T	1800	1780 - 1830	1773 - 1823	690		
<p>Porte in linea in linea - fissi in linea Schiebetüren in Linie - Festfelder Sliding doors in line - fix elements Puertas correderas in línea - elementos fijos</p>	0140 TI-S	1400	1380 - 1430	1373 - 1423		305	
	0160 TI-S	1600	1580 - 1630	1573 - 1623		355	
	0180 TI-S	1800	1780 - 1830	1773 - 1823		405	
<p>Laterale per porta scorrevole in linea Seitenteil für Schiebetür in Linie Side panel for sliding door in line Pared lateral para puerta in línea</p>	1070 TW	700	665 - 690	658 - 683			
	1075 TW	750	715 - 740	708 - 733			
	1080 TW	800	765 - 790	758 - 783			
	1090 TW	900	865 - 890	858 - 883			
	1100 TW	1000	965 - 990	958 - 983			

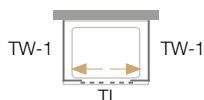
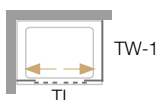

TOGA TC

PORTA SCORREVOLE
SCHIEBETÜR
SLIDING DOOR
PUERTA CORREDERA





SPECIAL				10	05	
01	06	09	70			

Descrizione Articolo Artikelbezeichnung Model description Descripción artículo	Articolo Artikel Model Código	Misura piatto doccia Tassenmaß Tray size Medidas del plato mm	Estensibilità Verstellbarkeit Adjustability Extensibilidad mm	Misura centro vetro Mitte Glasmaß Glass size middle Medida vidrio centro mm	Misura Maß Size Medidas mm A B		
<p>Box ad angolo scorrevole Eckkabine mit Schiebetüren Corner entry with sliding doors Cabina angular con puertas correderas</p>	0070 TC	700	665 - 690	658 - 683	330	405	
	0075 TC	750	715 - 740	708 - 733	365	430	
	0080 TC	800	765 - 790	758 - 783	400	455	
	0090 TC	900	865 - 890	858 - 883	470	505	
	0100 TC	1000	965 - 990	958 - 983	540	555	
	0120 TC	1200	1165 - 1190	1158 - 1183	680	655	
	0903 TC	SPECIAL		665 - 790			
	0905 TC	SPECIAL		791 - 990			
	0907 TC	SPECIAL		991 - 1210			

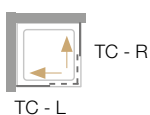

TOGA TD

PORTA GIREVOLE
DREHTÜR
PIVOT DOOR
PUERTA GIRATORIA





SPECIAL				10	05	
01	06	09	70			

Descrizione Articolo Artikelbezeichnung Model description Descripción artículo	Articolo Artikel Model Código	Misura piatto doccia Tassenmaß Tray size Medidas del plato mm	Estensibilità Verstellbarkeit Adjustability Extensibilidad mm	Misura Maß Size Medidas mm		
				A	B	C
<p>Porta girevole Drehtür Pivot door Puerta giratoria</p> <p>IN OUT</p>	0070 TD	700	658 - 708	480	480	150
	0075 TD	750	708 - 758	530	530	150
	0080 TD	800	758 - 808	530	530	200
	0090 TD	900	858 - 908	630	630	200
	0100 TD	1000	958 - 1008	730	730	200
<p>Laterale per vasca Seitenteil für Badewanne Side panel for bathtub Pared lateral para bañera</p>	0015 TB*	700 - 1000	25			

* Articolo é sempre un fuori misura / Artikel ist immer Sondermaß / article is always special measure / artículo es siempre medida especial

Indicare sempre bordo piatto fino bordo vasca/muretto
Oberkante Duschtasse bis Badewanne/Mauer immer angeben
Indicate always shower tray to bathtub panel/wall
Indique siempre borde superior plato de ducha y bañera/muro



TOGA TD + TW-1

PORTA GIREVOLE CON LATERALE

DREHTÜR MIT SEITENTEIL

PIVOT DOOR WITH SIDE PANEL

PUERTA GIRATORIA CON PARED LATERAL





TD 2000	TW-1 2000	
-------------------	---------------------	--

GH High Glass	GL	6 mm
-------------------------	-----------	-------------

SPECIAL				10	05	
01	06	09	70			

Descrizione Articolo Artikelbezeichnung Model description Descripción artículo	Articolo Artikel Model Código	Misura piatto doccia Tassenmaß Tray size Medidas del plato mm	Estensibilità Verstellbarkeit Adjustability Extensibilidad mm	Misura centro vetro Mitte Glasmaß Glass size middle Medida vidrio centro mm	Misura Maß Size Medidas mm		
					A	B	C
 Porta girevole Drehtür Pivot door Puerta giratoria	0070 TD	700	670 - 720		480	480	150
	0075 TD	750	720 - 770		530	530	150
	0080 TD	800	770 - 820		530	530	200
	0090 TD	900	870 - 920		630	630	200
	0100 TD	1000	970 - 1020		730	730	200
 Laterale Seitenteil Side panel Pared lateral	1070 TW	700	665 - 690	660 - 685			
	1075 TW	750	715 - 740	710 - 735			
	1080 TW	800	765 - 790	760 - 785			
	1090 TW	900	865 - 890	860 - 885			
	1100 TW	1000	965 - 990	960 - 985			

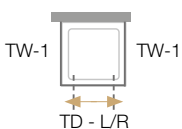

TOGA TD-1

PORTA GIREVOLE IN LINEA

DREHTÜR IN LINIE

PIVOT DOOR INLINE

PUERTA GIRATORIA EN LINEA





SPECIAL				10	05	
01	06	09	70			



Descrizione Articolo Artikelbezeichnung Model description Descripción artículo	Articolo Artikel Model Código	Misura piatto doccia Tassenmaß Tray size Medidas del plato mm	Estensibilità Verstellbarkeit Adjustability Extensibilidad mm	Misura Maß Size Medidas mm			
				A	B	C	D
<p>Porta girevole in linea Drehtür in Linie Pivot door in-line Puerta giratoria en línea</p>	1100 TD	1000	958 - 1008	530	530	200	230
	1120 TD	1200	1158 - 1208	630	630	200	330
	1140 TD	1400	1358 - 1408	730	730	200	430
<p>Laterale per vasca Seitenteil für Badewanne Side panel for bathtub Pared lateral para bañera</p>	0015 TB*	700 - 1000	25				

* Articolo é sempre un fuori misura / Artikel ist immer Sondermaß / article is always special measure / artículo es siempre medida especial

	<p>Indicare sempre bordo piatto fino bordo vasca/muretto Oberkante Duschtasse bis Badewanne/Mauer immer angeben Indicate always shower tray to bathtub panel/wall Indique siempre borde superior plato de ducha y bañera/muro</p>

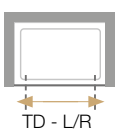

TOGA TD-1 + TW-1

PORTA GIREVOLE IN LINEA CON LATERALE

DREHTÜR IN LINIE MIT SEITENTEIL

PIVOT DOOR INLINE WITH SIDE PANEL

PUERTA GIRATORIA EN LINEA CON PARED LATERAL





TD-1 2000	TW-1 2000	
---------------------	---------------------	--

GH High Glass	GL	6 mm
-------------------------	-----------	-------------

SPECIAL				10	05	
01	06	09	70			

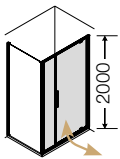
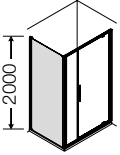
Descrizione Articolo Artikelbezeichnung Model description Descripción artículo	Articolo Artikel Model Código	Misura piatto doccia Tassenmaß Tray size Medidas del plato mm	Estensibilità Verstellbarkeit Adjustability Extensibilidad mm	Misura centro vetro Mitte Glasmaß Glass size middle Medida vidrio centro mm	Misura Maß Size Medidas mm			
					A	B	C	D
 <p>Porta girevole in linea Drehtür in Linie Pivot door in-line Puerta giratoria en línea</p>	1100 TD	1000	970 - 1020		530	530	200	230
	1120 TD	1200	1170 - 1220		630	630	200	330
	1140 TD	1400	1370 - 1420		730	730	200	430
 <p>Laterale Seitenteil Side panel Pared lateral</p>	1070 TW	700	665 - 690	660 - 685				
	1075 TW	750	715 - 740	710 - 735				
	1080 TW	800	765 - 790	760 - 785				
	1090 TW	900	865 - 890	860 - 885				
	1100 TW	1000	965 - 990	960 - 985				

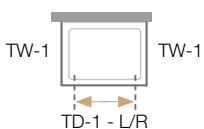

TOGA TD-2

PORTA GIREVOLE CON FISSO
DREHTÜR MIT FESTFELD
PIVOT DOOR WITH FIX PANEL
PUERTA GIRATORIA CON FIJO





SPECIAL				10	05	
01	06	09	70			



Descrizione Articolo Artikelbezeichnung Model description Descripción artículo	Articolo Artikel Model Código	Misura piatto doccia Tassenmaß Tray size Medidas del plato mm	Estensibilità Verstellbarkeit Adjustability Extensibilidad mm	Misura Maß Size Medidas mm			
				A	B	C	
<p>Porta girevole con fisso Drehtür mit Festfeld Pivot door with fix panel Puerta giratoria con fijo</p>	2100 TD	1000	950 - 1000	530	530	390	
	2120 TD	1200	1150 - 1200	630	630	490	
	2140 TD	1400	1350 - 1400	730	730	590	

<p>Laterale per vasca Seitenteil für Badewanne Side panel for bathtub Pared lateral para bañera</p>	0015 TB*	700 - 1000	25				

* Articolo é sempre un fuori misura / Artikel ist immer Sondermaß / article is always special measure / artículo es siempre medida especial

	Indicare sempre bordo piatto fino bordo vasca/muretto
	Oberkante Duschtasse bis Badewanne/Mauer immer angeben Indicate always shower tray to bathtub panel/wall Indique siempre borde superior plato de ducha y bañera/muro

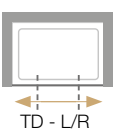

TOGA TD-2 + TW-1

PORTA GIREVOLE CON FISSO E LATERALE
DREHTÜR MIT FESTFELD UND SEITENTEIL
PIVOT DOOR WITH FIX AND SIDE PANEL
PUERTA GIRATORIA CON FIJO Y PARED LATERAL





TD-2 2000	TW-1 2000	
---------------------	---------------------	--

GH High Glass	GL	6 mm
-------------------------	-----------	-------------

SPECIAL				10	05	
01	06	09	70			

Descrizione Articolo Artikelbezeichnung Model description Descripción artículo	Articolo Artikel Model Código	Misura piatto doccia Tassenmaß Tray size Medidas del plato mm	Estensibilità Verstellbarkeit Adjustability Extensibilidad mm	Misura centro vetro Mitte Glasmaß Glass size middle Medida vidrio centro mm	Misura Maß Size Medidas mm			
					A	B	C	
<p>Porta girevole con fisso Drehtür mit Festfeld Pivot door with fix panel Puerta giratoria con fijo</p> <p>IN OUT</p>	2100 TD	1000	962 - 1012		530	530	390	
	2120 TD	1200	1162 - 1212		630	630	490	
	2140 TD	1400	1362 - 1412		730	730	590	
<p>Laterale Seitenteil Side panel Pared lateral</p>	1070 TW	700	665 - 690	660 - 685				
	1075 TW	750	715 - 740	710 - 735				
	1080 TW	800	765 - 790	760 - 785				
	1090 TW	900	865 - 890	860 - 885				
	1100 TW	1000	965 - 990	960 - 985				

